

VIEWMOUNT 2

2 BEDROOM
1798 SQ. FT.

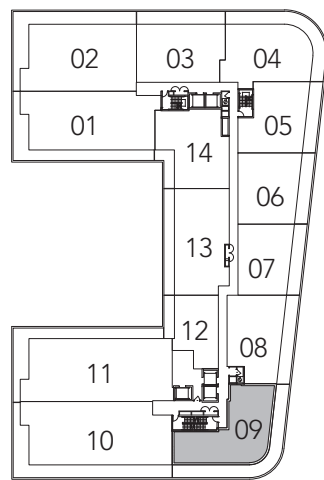

FLOOR 4

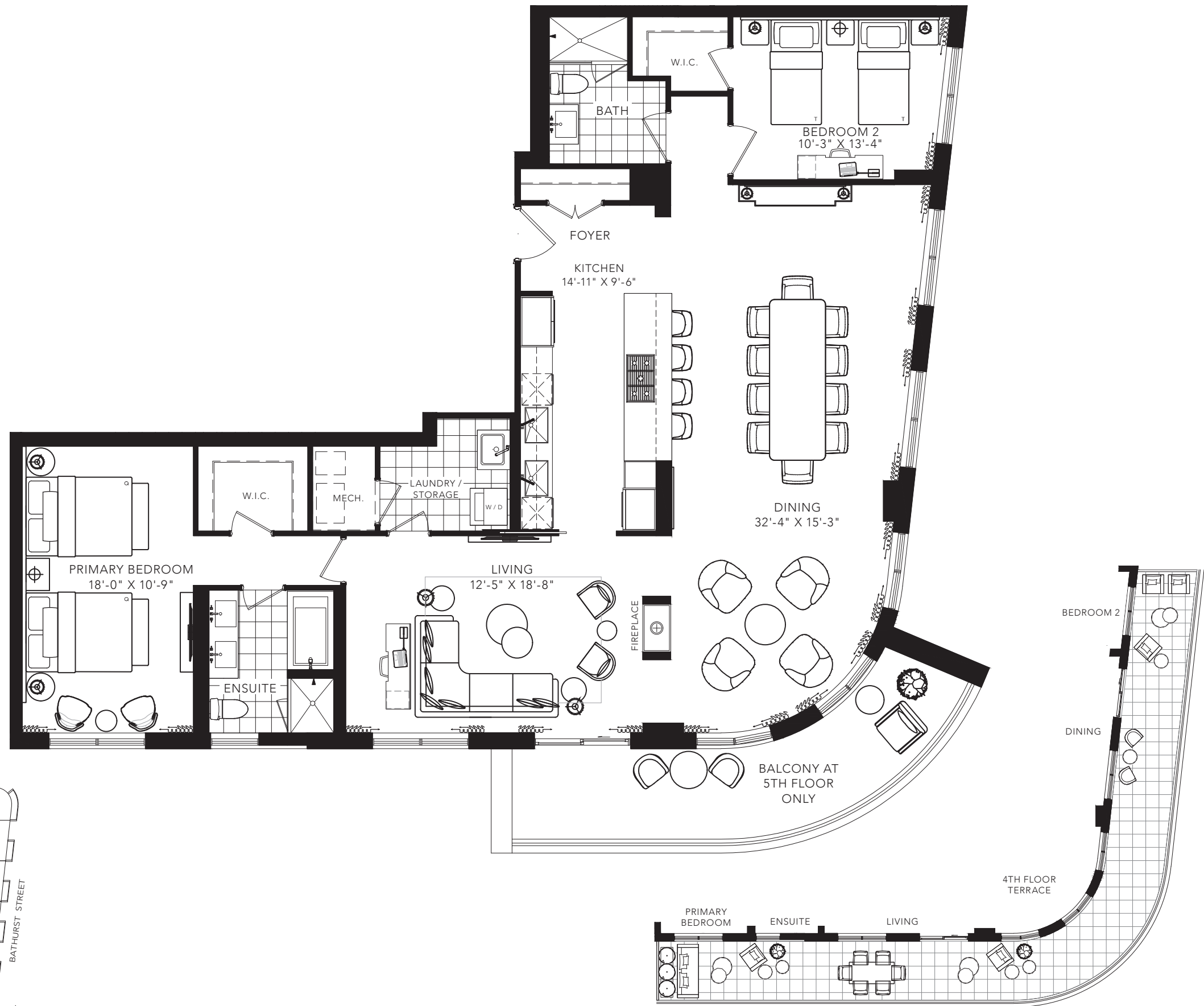
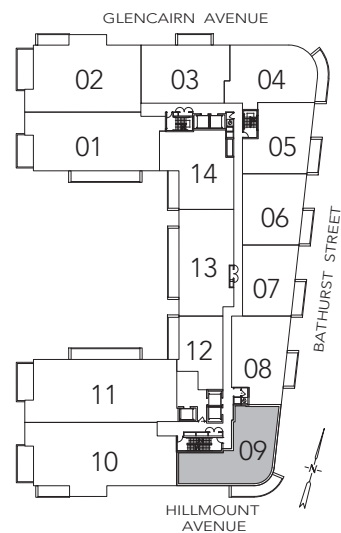

FLOOR 5

All areas and stated room dimensions are approximate. Floor area measured in accordance with Tarion requirements. Actual living area will vary from floor area stated. Furniture not included. Plan may be reversed. All illustrations are artist's concept. E. & O.E. March 2022.

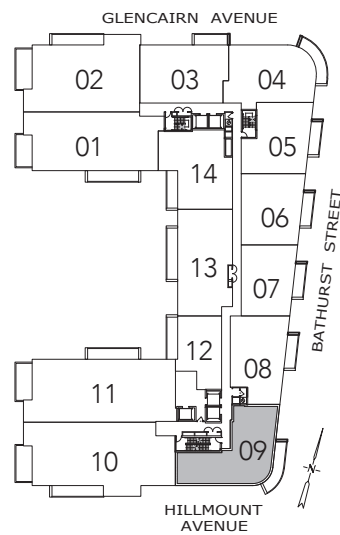

FLOOR 6

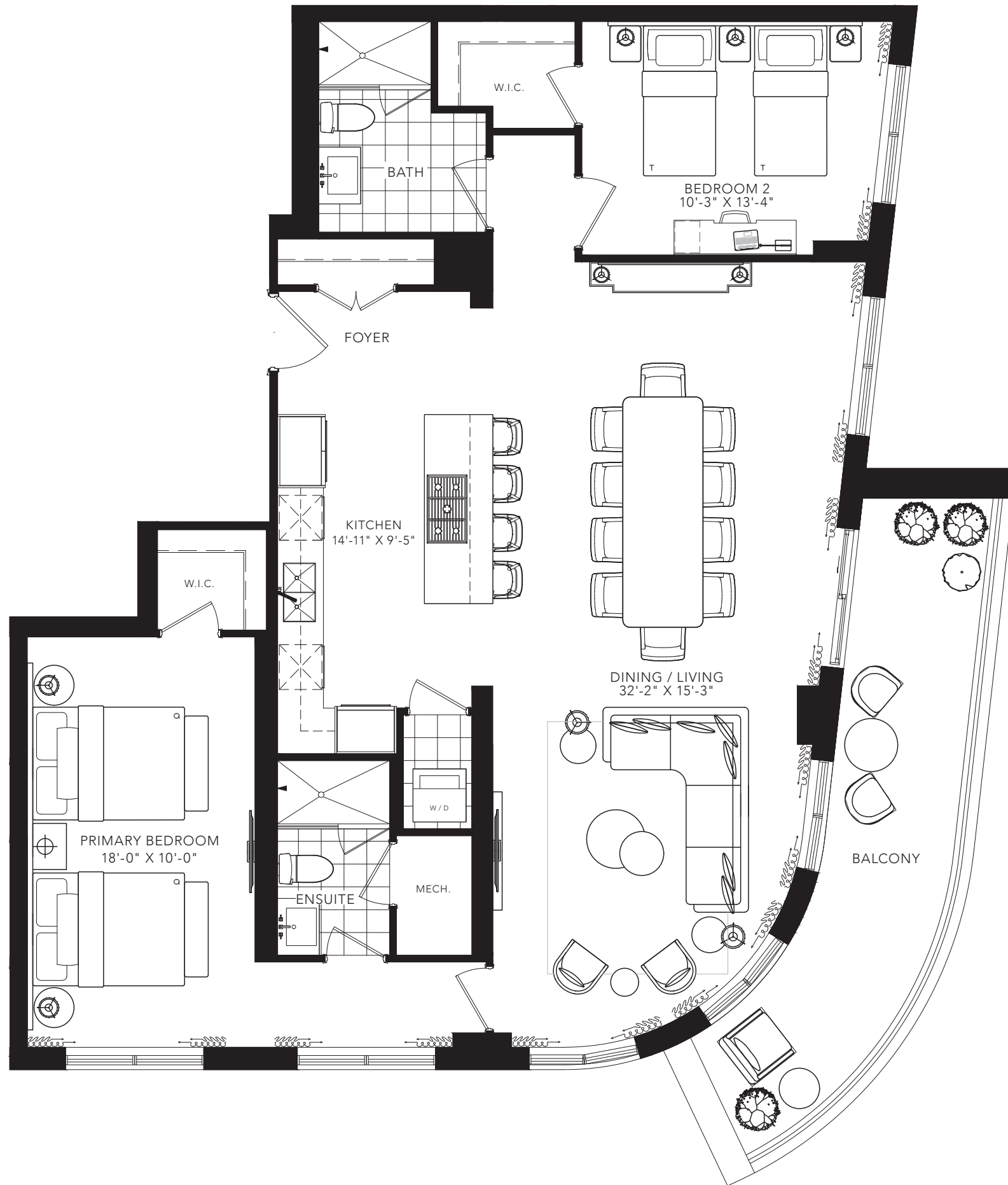

All areas and stated room dimensions are approximate. Floor area measured in accordance with Tarion requirements. Actual living area will vary from floor area stated. Furniture not included. Plan may be reversed. All illustrations are artist's concept. E. & O.E. March 2022.

KIRKLAND

2 BEDROOM + DEN
1851 SQ. FT.

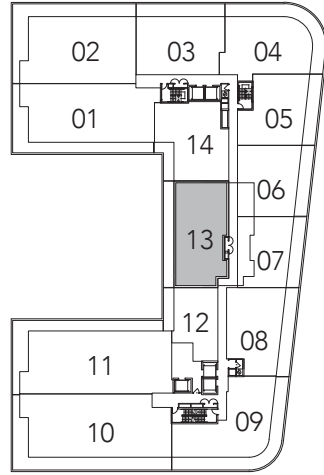

FLOOR 4

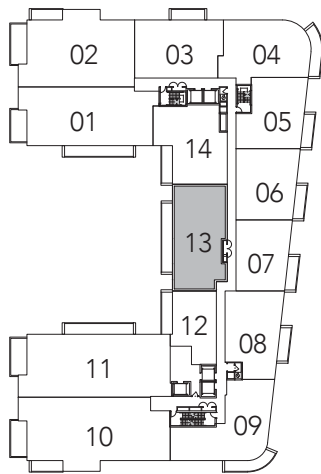

FLOOR 5

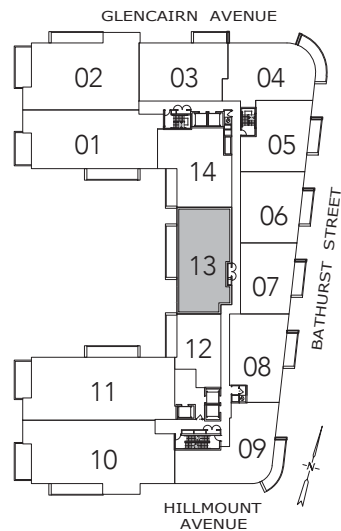

FLOOR 6

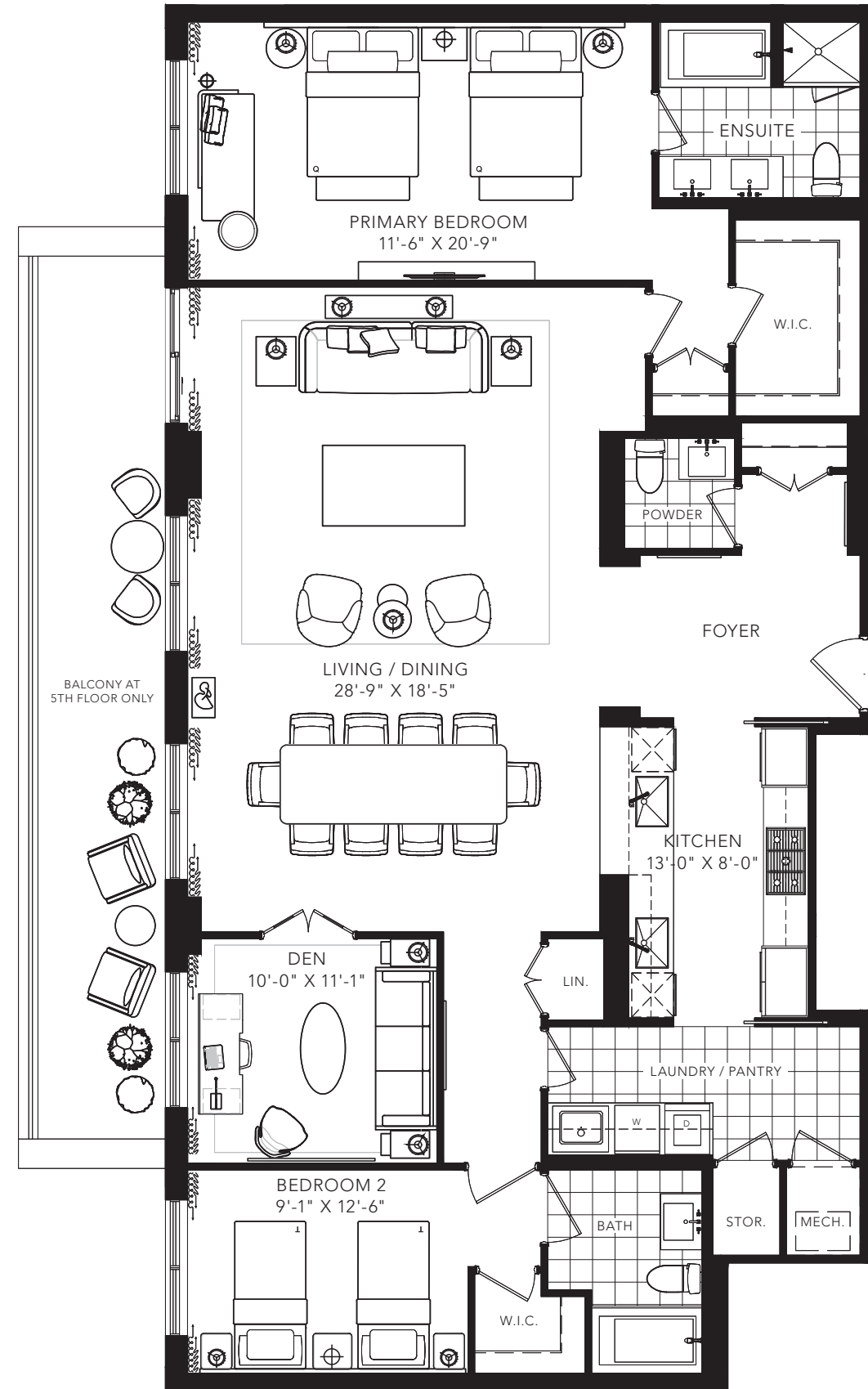
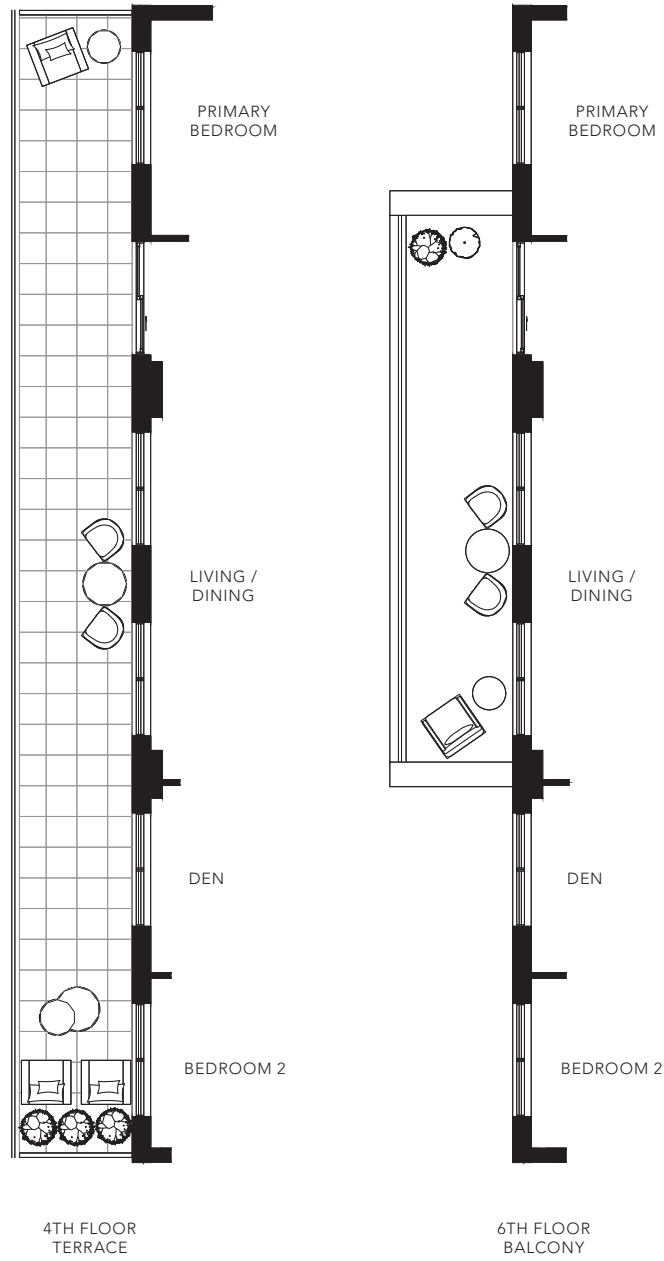

All areas and stated room dimensions are approximate. Floor area measured in accordance with Tarion requirements. Actual living area will vary from floor area stated. Furniture not included. Plan may be reversed. All illustrations are artist's concept. E. & O.E. May 2021.



GLENHILL

CONDOMINIUMS

GLENGROVE

3 BEDROOM

2419 SQ. FT.

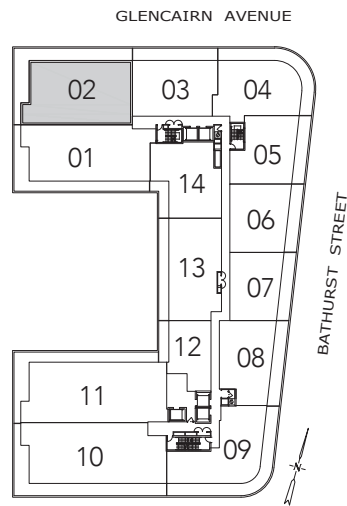
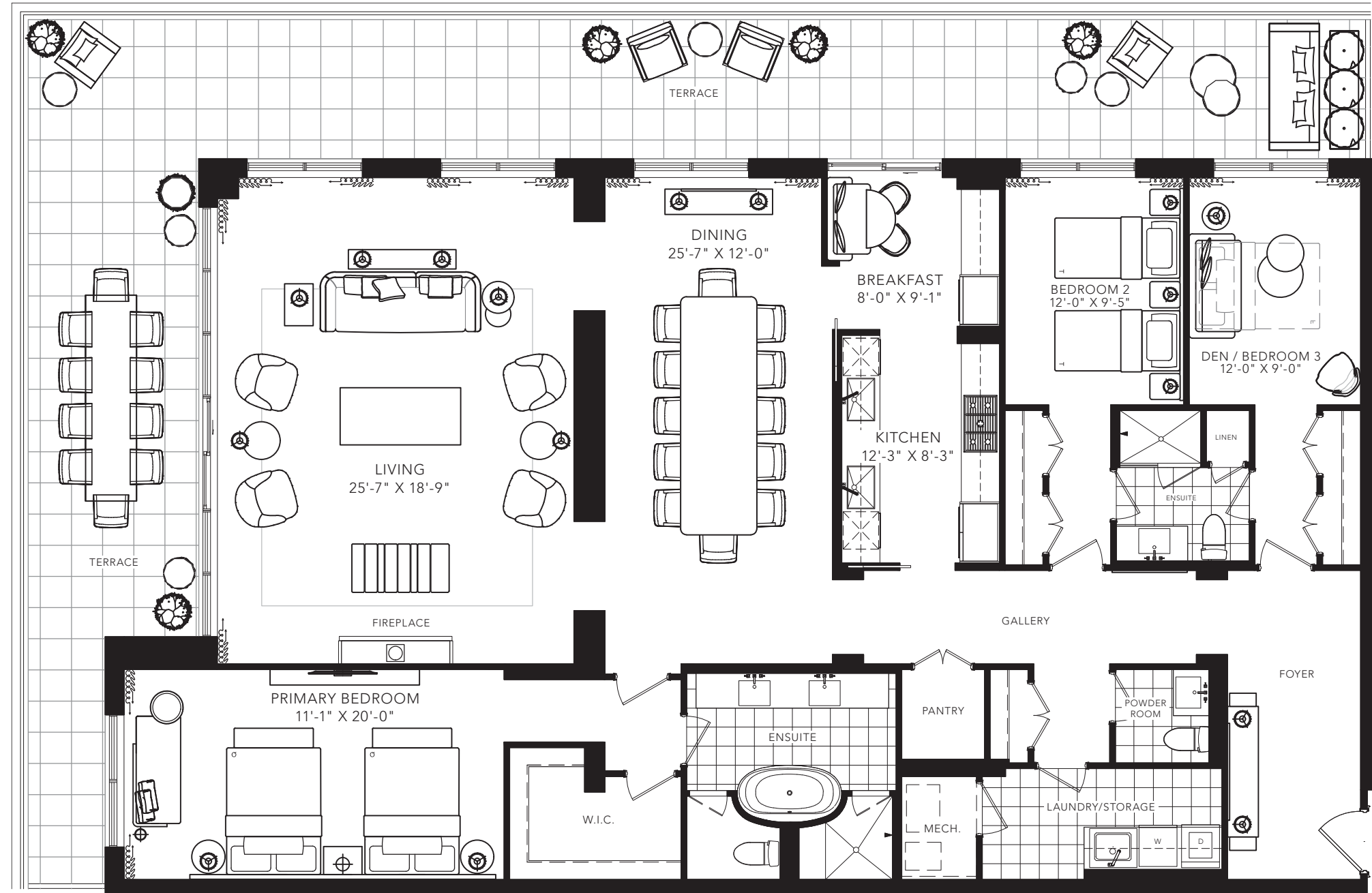

HILLMOUNT AVENUE
FLOOR 4

All areas and stated room dimensions are approximate. Floor area measured in accordance with Tarion requirements. Actual living area will vary from floor area stated. Furniture not included. Plan may be reversed. All illustrations are artist's concept. E. & O.E. May 2021.



GLENHILL

CONDOMINIUMS

MELROSE

3 BEDROOM

2549 SQ. FT.

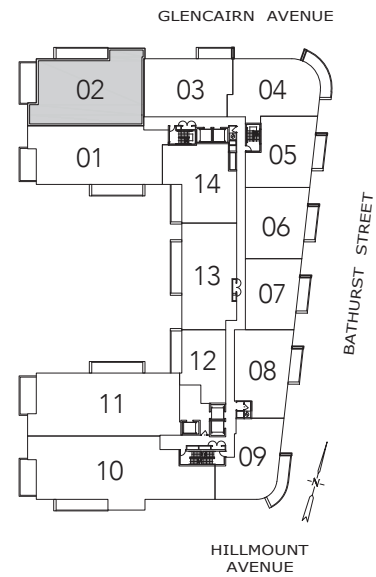
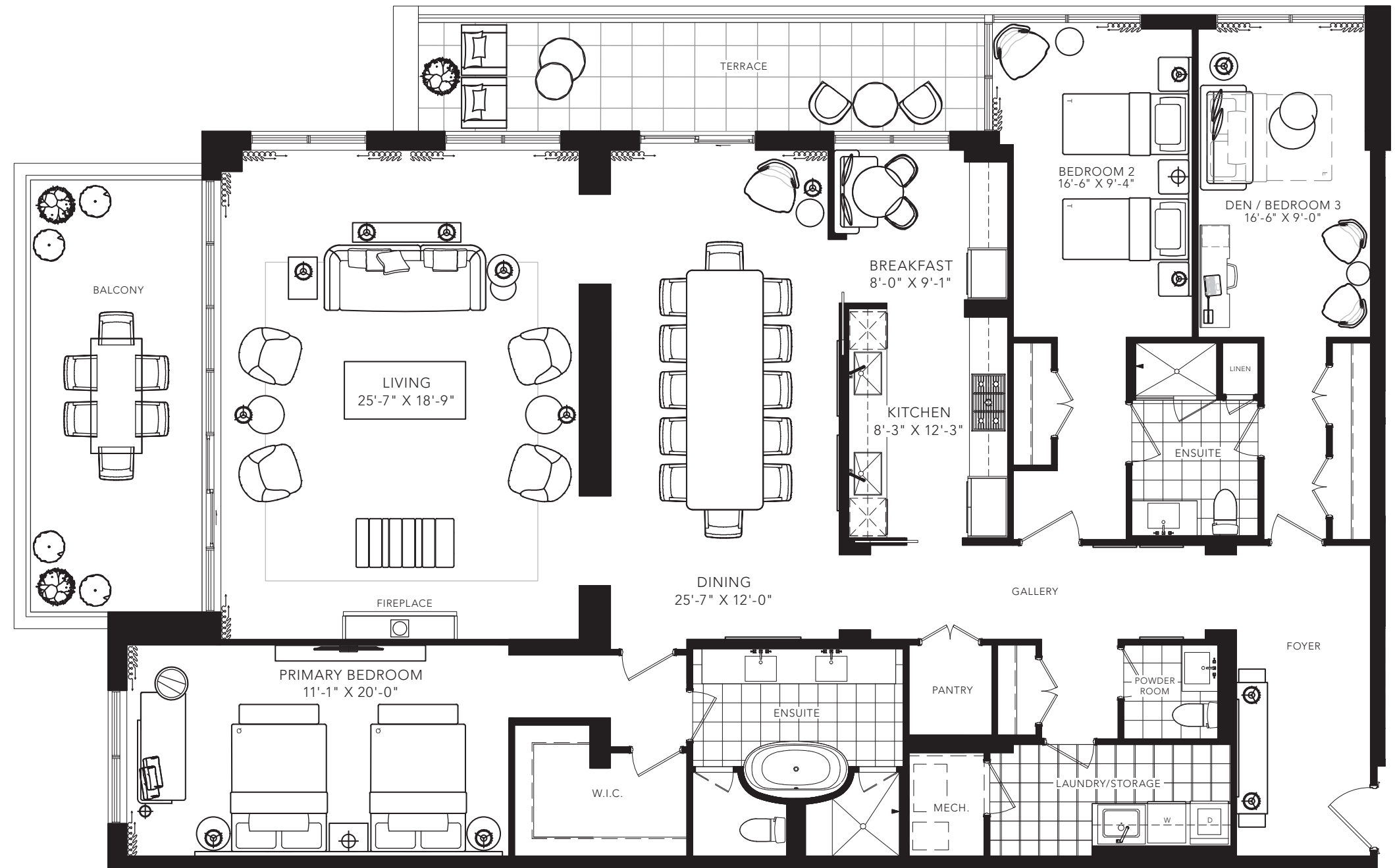

FLOOR 6

All areas and stated room dimensions are approximate. Floor area measured in accordance with Tarion requirements. Actual living area will vary from floor area stated. Furniture not included. Plan may be reversed. All illustrations are artist's concept. E. & O.E. May 2021.



GLENHILL

CONDOMINIUMS

LYTTON

3 BEDROOM

2551 SQ. FT.

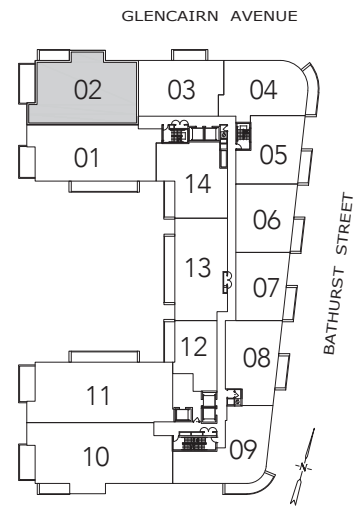
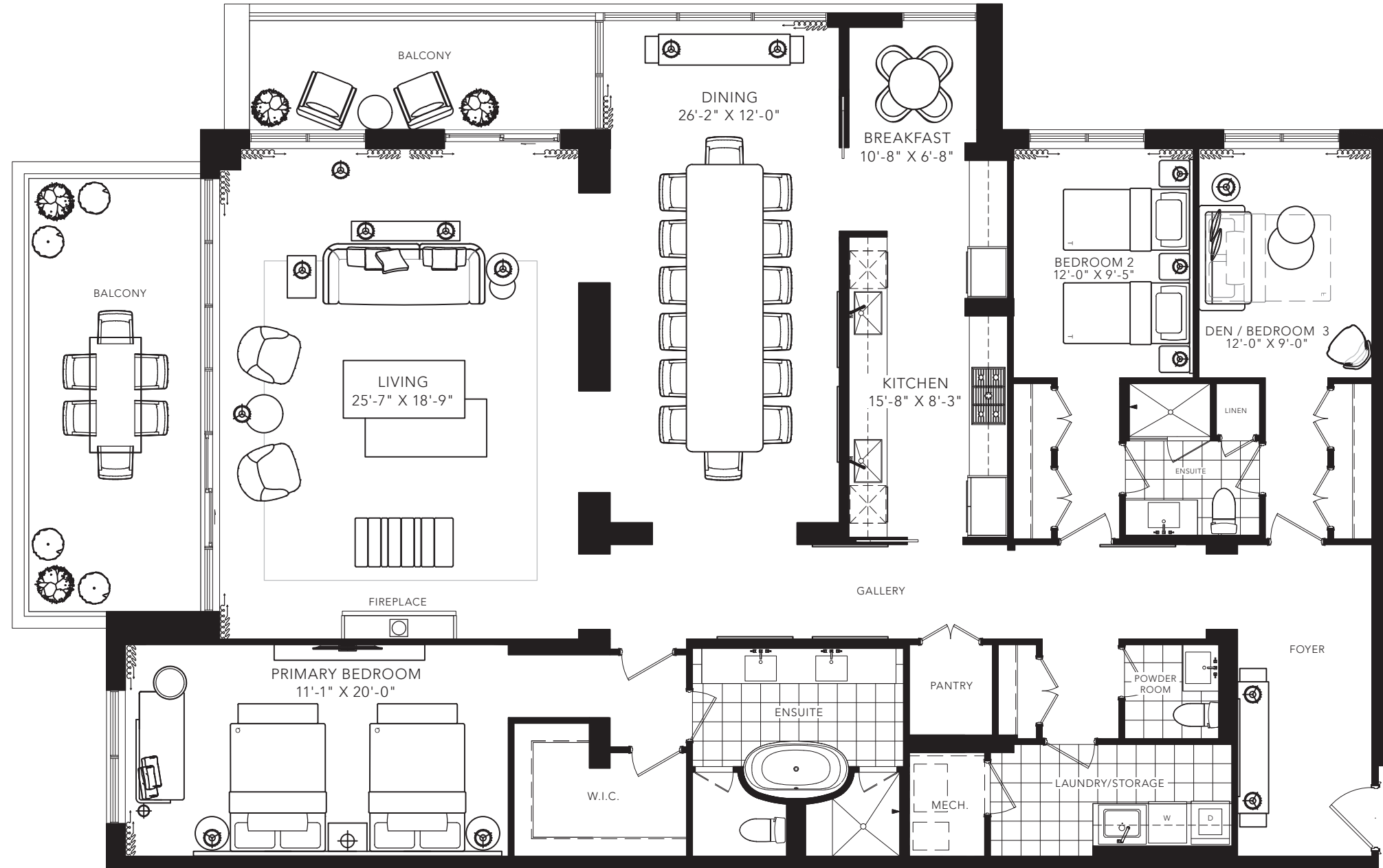

HILLMOUNT AVENUE
FLOOR 5

All areas and stated room dimensions are approximate. Floor area measured in accordance with Tarion requirements. Actual living area will vary from floor area stated. Furniture not included. Plan may be reversed. All illustrations are artist's concept. E. & O.E. May 2021.

OLIVE

3 BEDROOM + 2 DENS
 3476 SQ. FT.

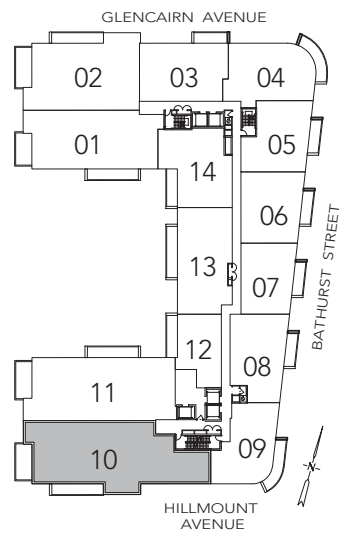
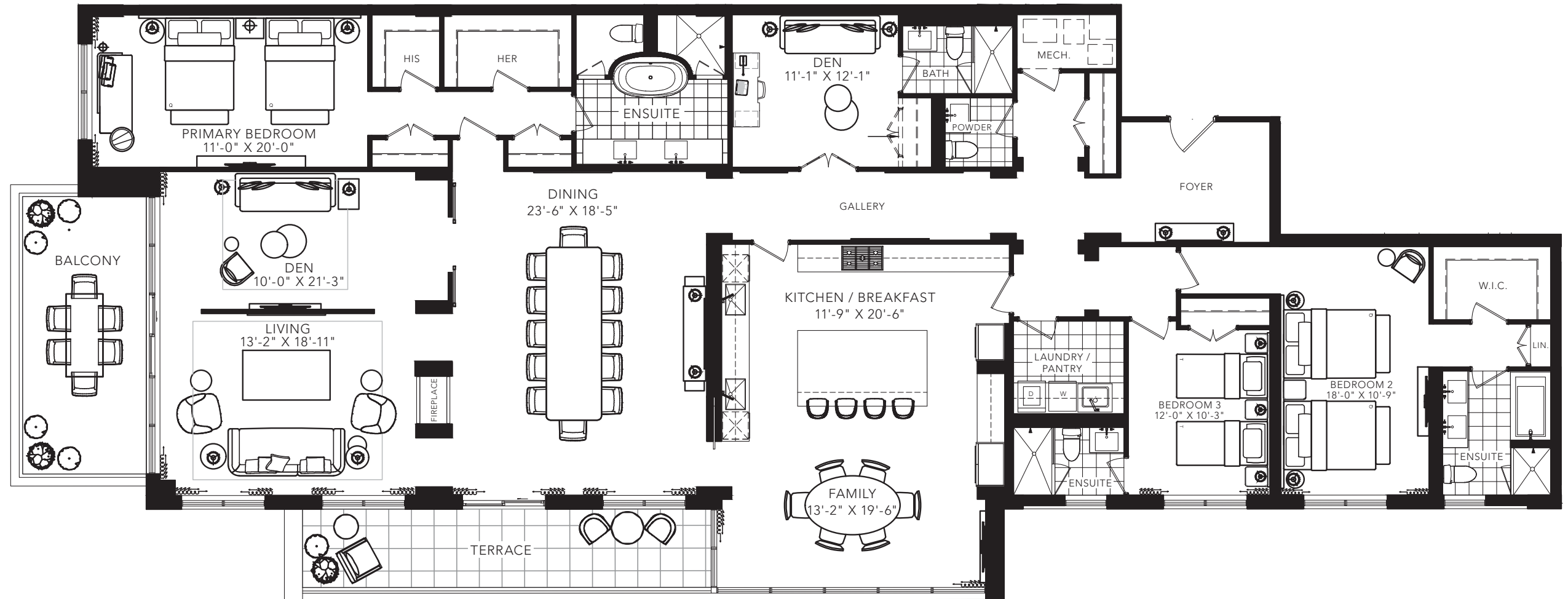

FLOOR 6

All areas and stated room dimensions are approximate. Floor area measured in accordance with Tarion requirements. Actual living area will vary from floor area stated. Furniture not included. Plan may be reversed. All illustrations are artist's concept. E. & O.E. May 2021.

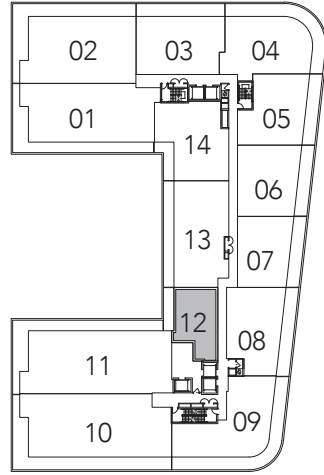

FLOOR 4

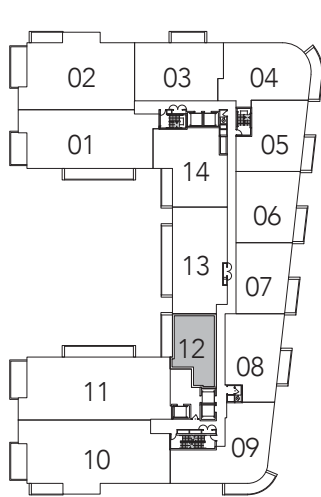

FLOOR 5

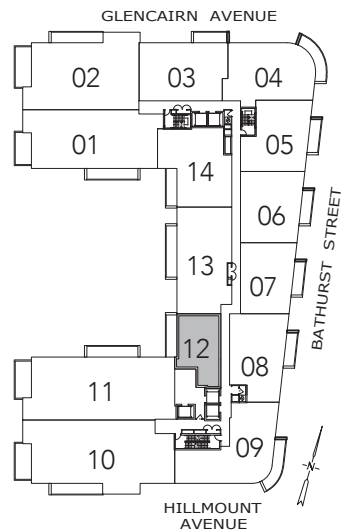

FLOOR 6

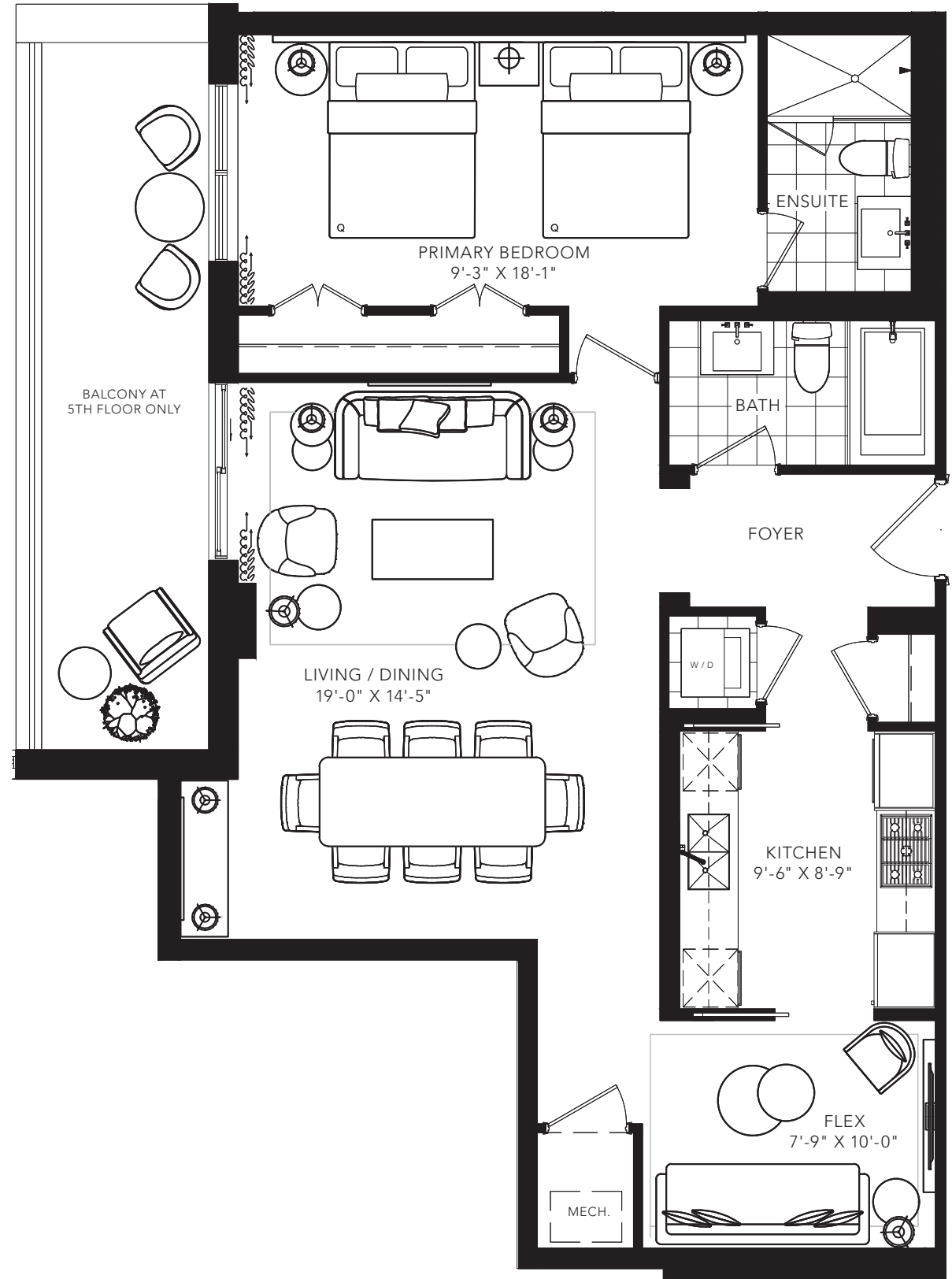
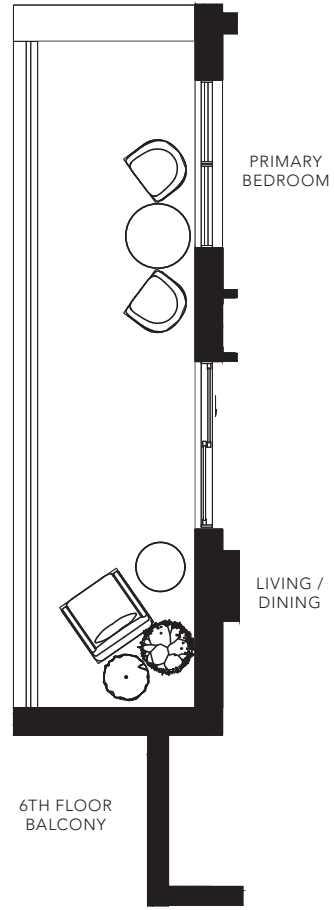
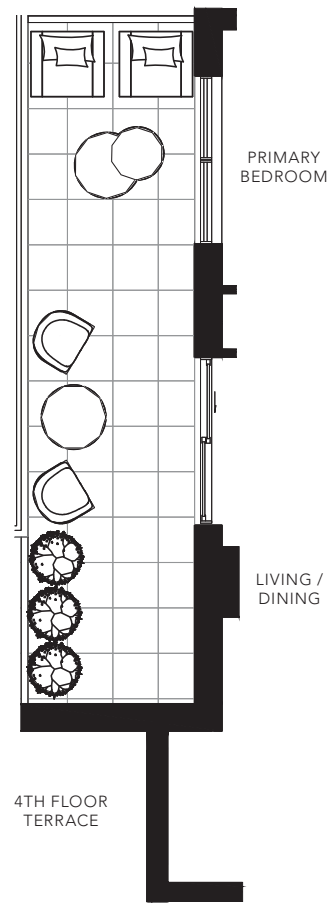

All areas and stated room dimensions are approximate. Floor area measured in accordance with Tarion requirements. Actual living area will vary from floor area stated. Furniture not included. Plan may be reversed. All illustrations are artist's concept. E. & O.E. May 2021.

KELSO 2

2 BEDROOM + DEN
1216 SQ.FT.

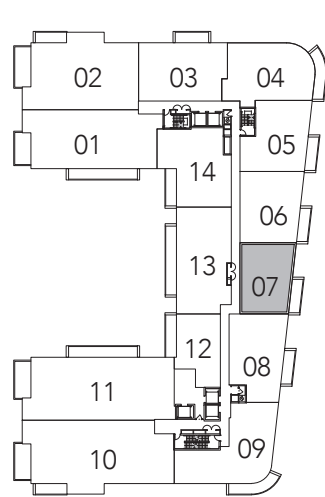

FLOOR 5

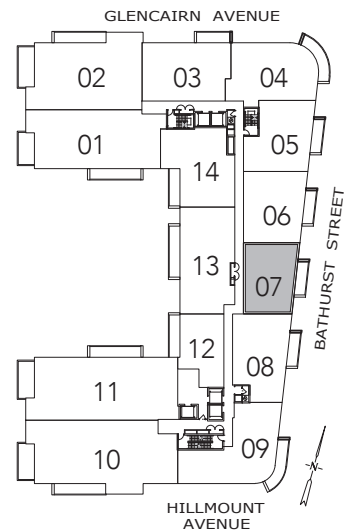

FLOOR 6

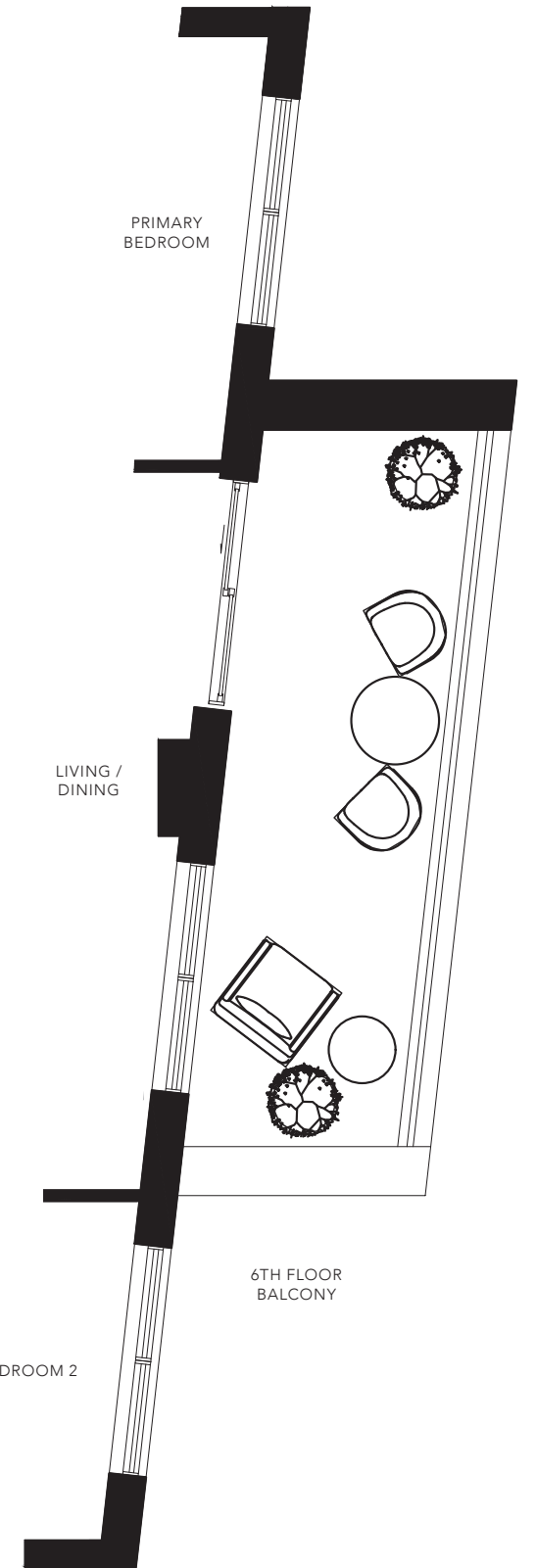
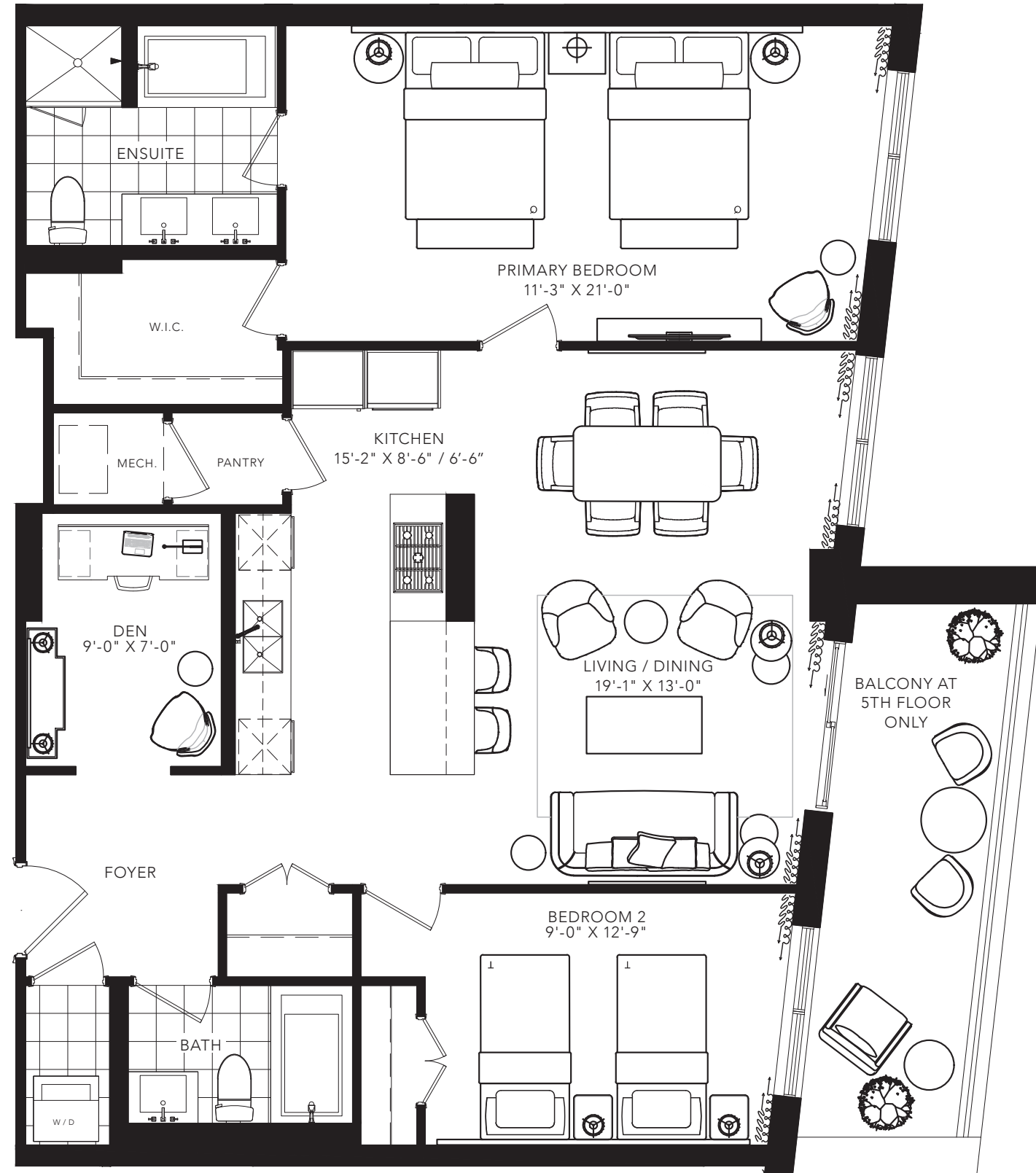

All areas and stated room dimensions are approximate. Floor area measured in accordance with Tarion requirements. Actual living area will vary from floor area stated. Furniture not included. Plan may be reversed. All illustrations are artist's concept. E. & O.E. March 2022.

HELENA

2 BEDROOM + DEN
1406 SQ. FT.

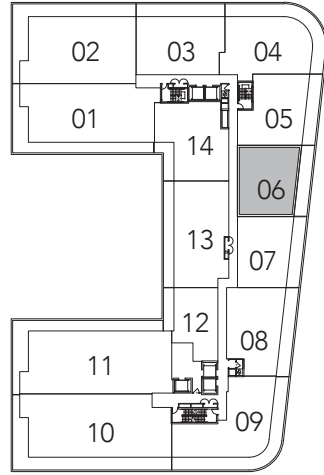

FLOOR 4

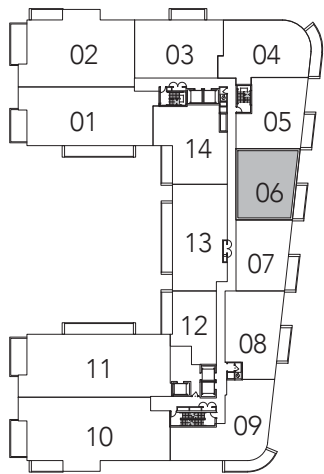

FLOOR 5

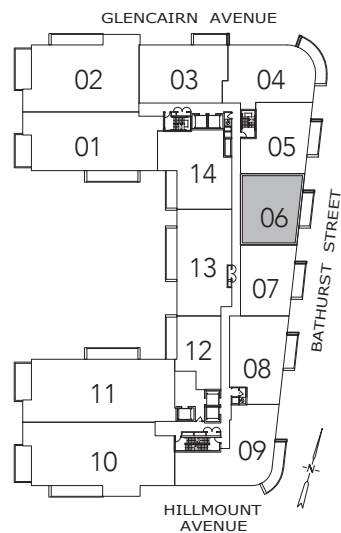

FLOOR 6

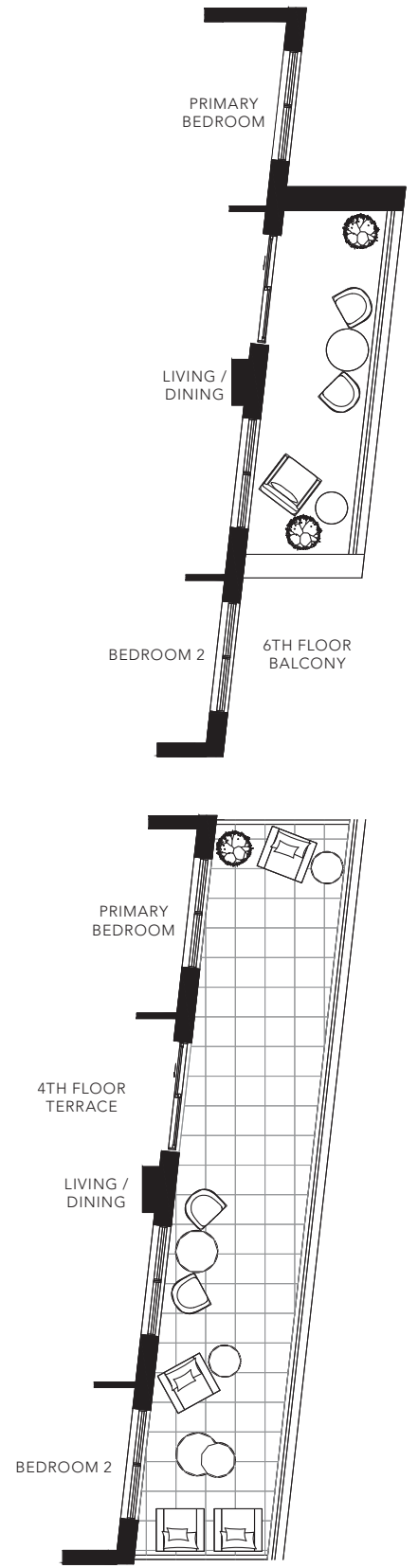
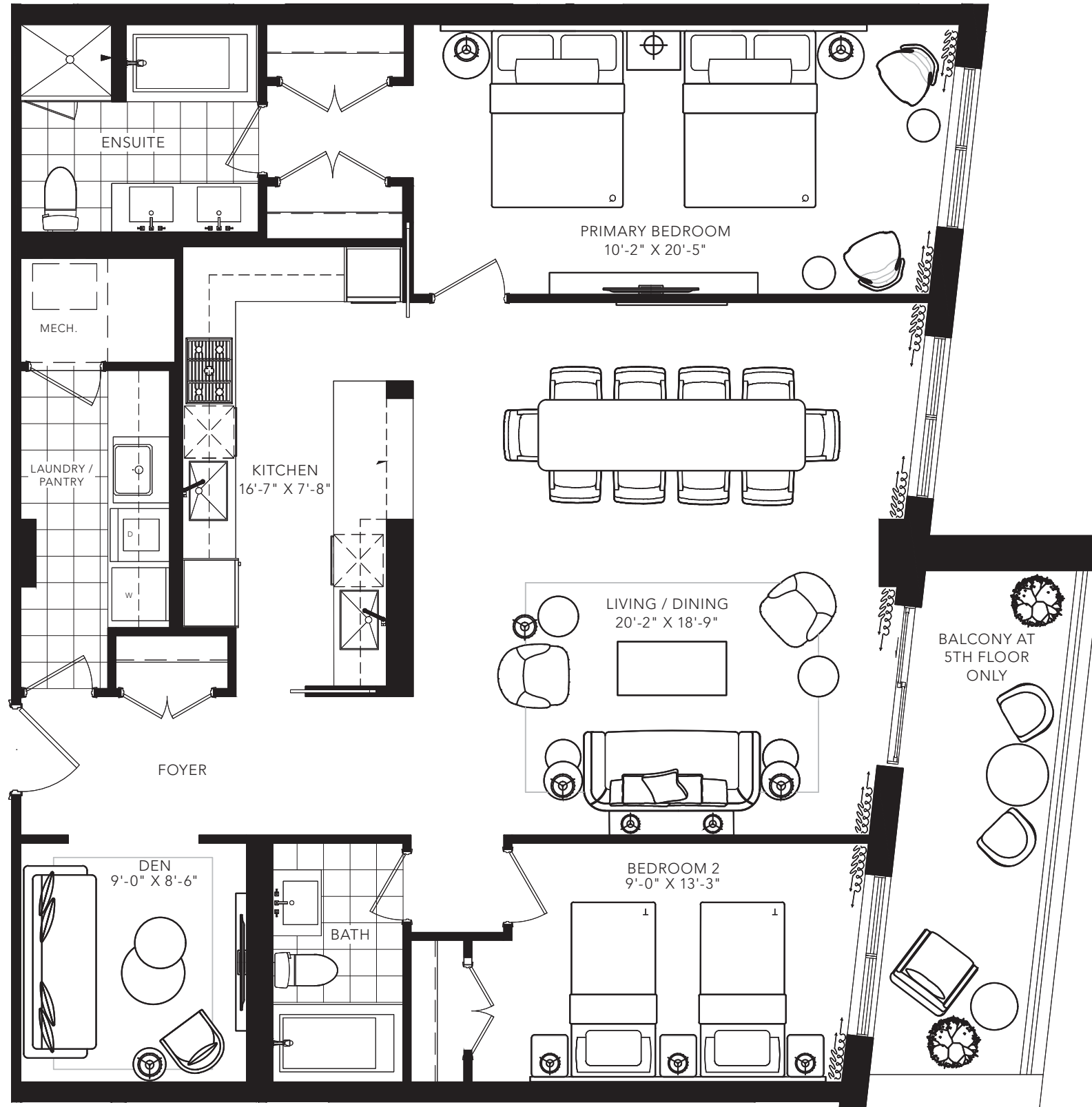

All areas and stated room dimensions are approximate. Floor area measured in accordance with Tarion requirements. Actual living area will vary from floor area stated. Furniture not included. Plan may be reversed. All illustrations are artist's concept. E. & O.E. May 2021.

HADDINGTON

2 BEDROOM + DEN
1420 SQ. FT.

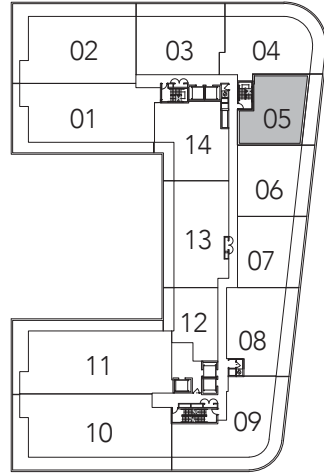

FLOOR 4

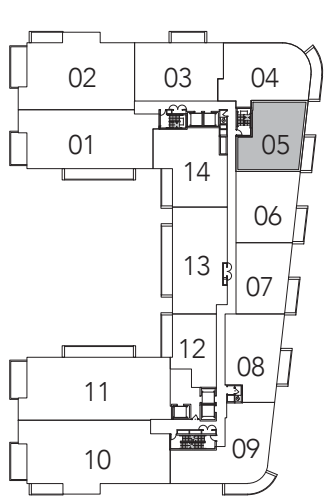

FLOOR 5

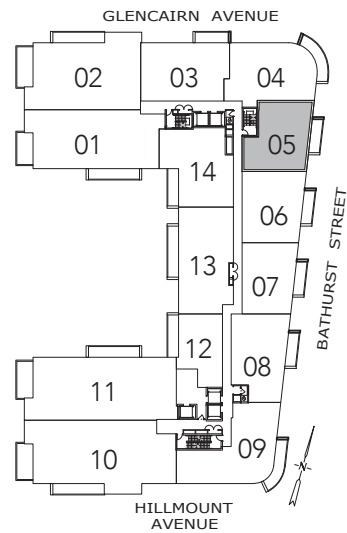

FLOOR 6

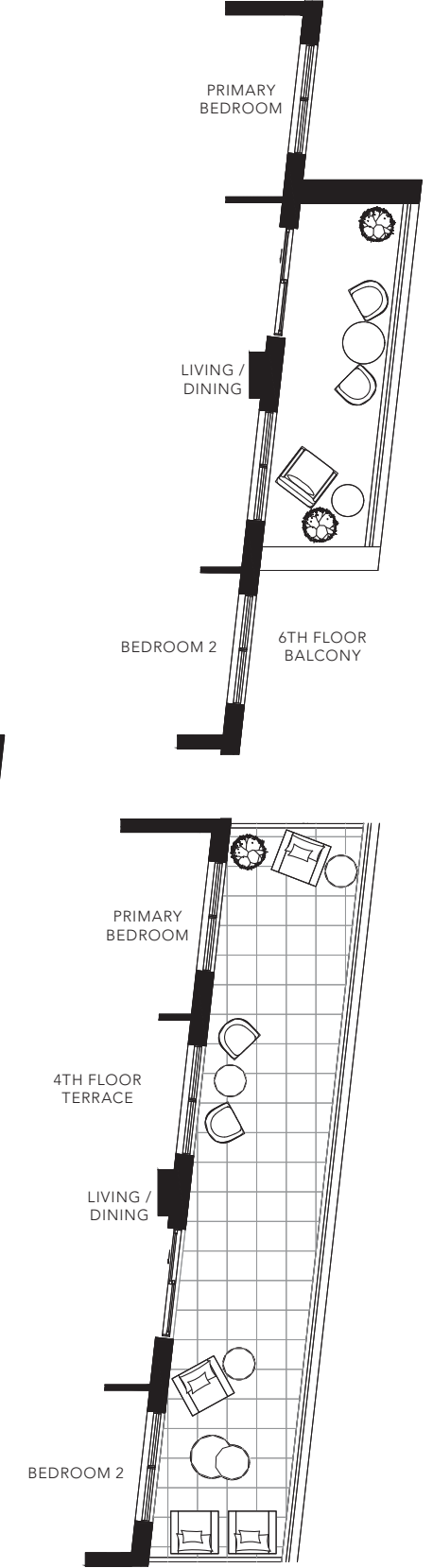
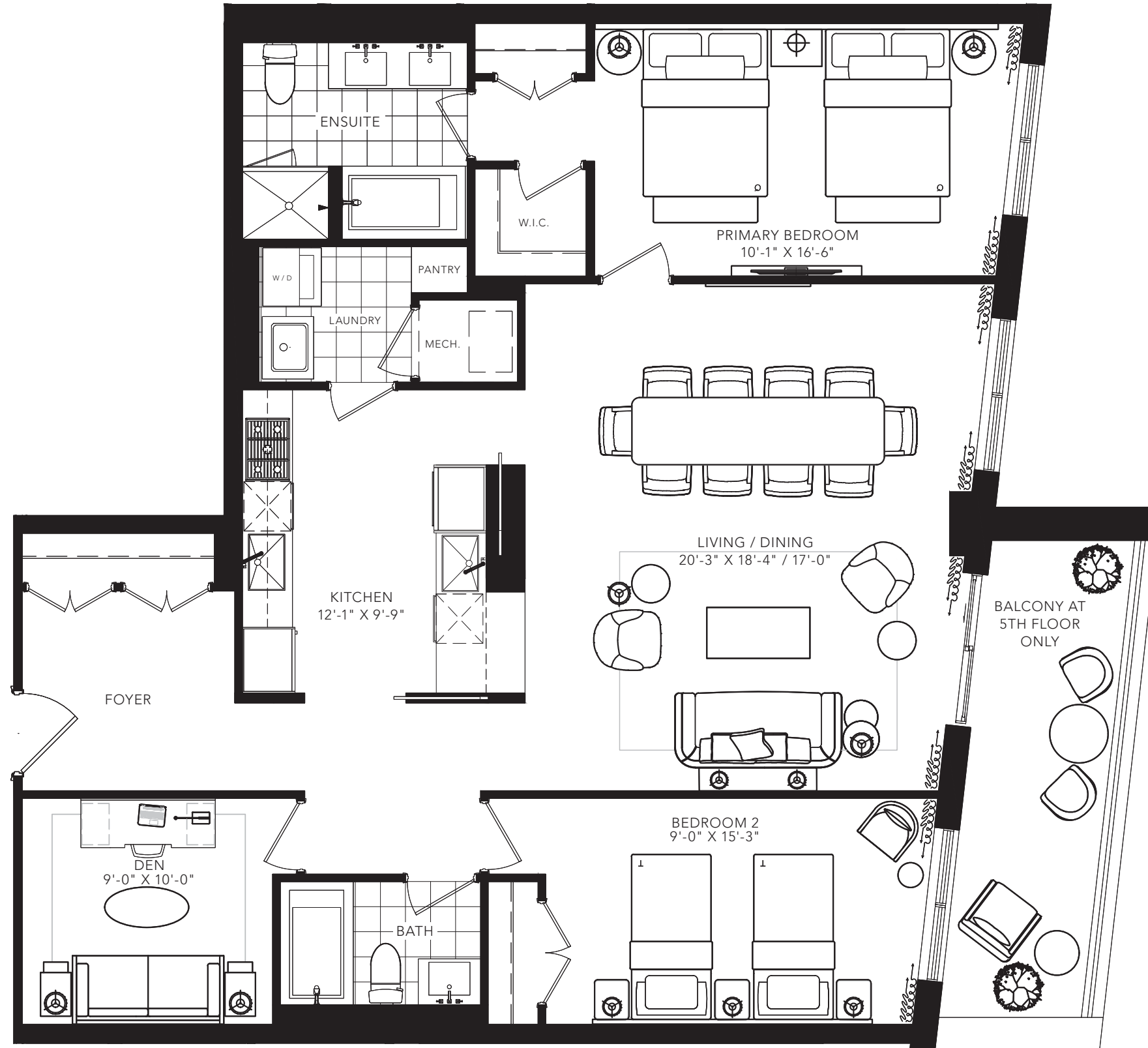

All areas and stated room dimensions are approximate. Floor area measured in accordance with Tarion requirements. Actual living area will vary from floor area stated. Furniture not included. Plan may be reversed. All illustrations are artist's concept. E. & O.E. May 2021.

OWEN 2

3 BEDROOM
1492 SQ. FT.

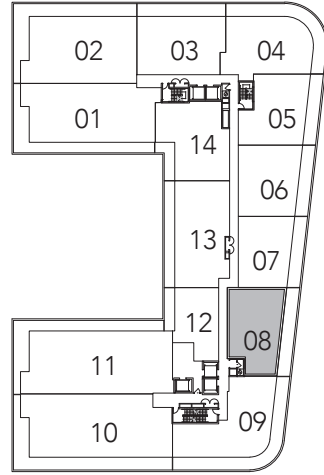

FLOOR 4

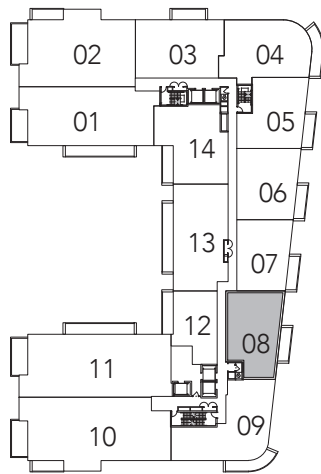

FLOOR 5

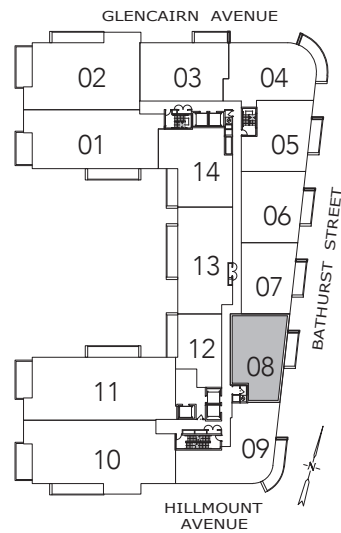

FLOOR 6

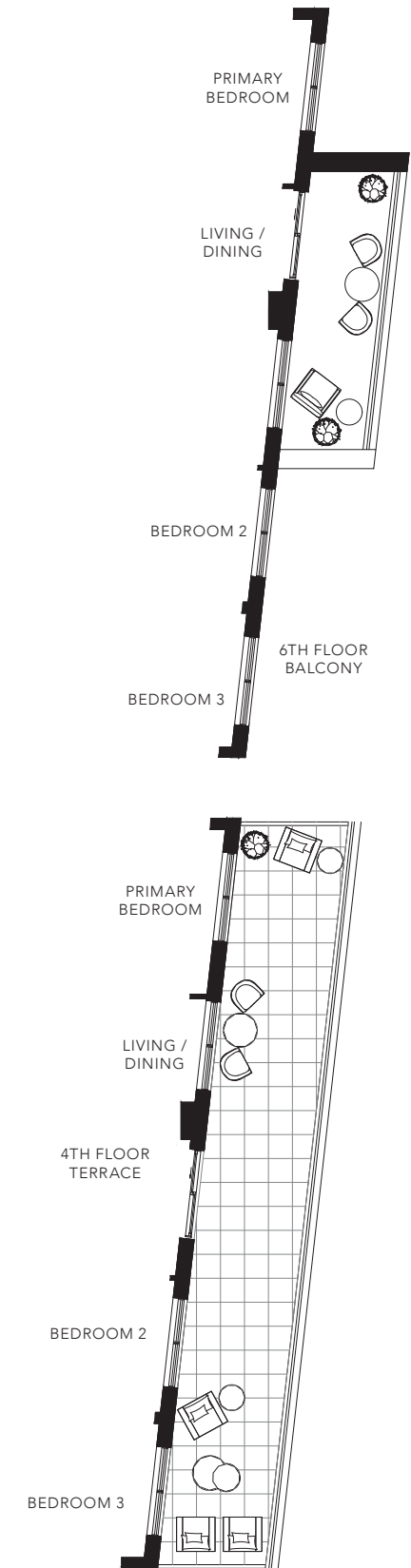
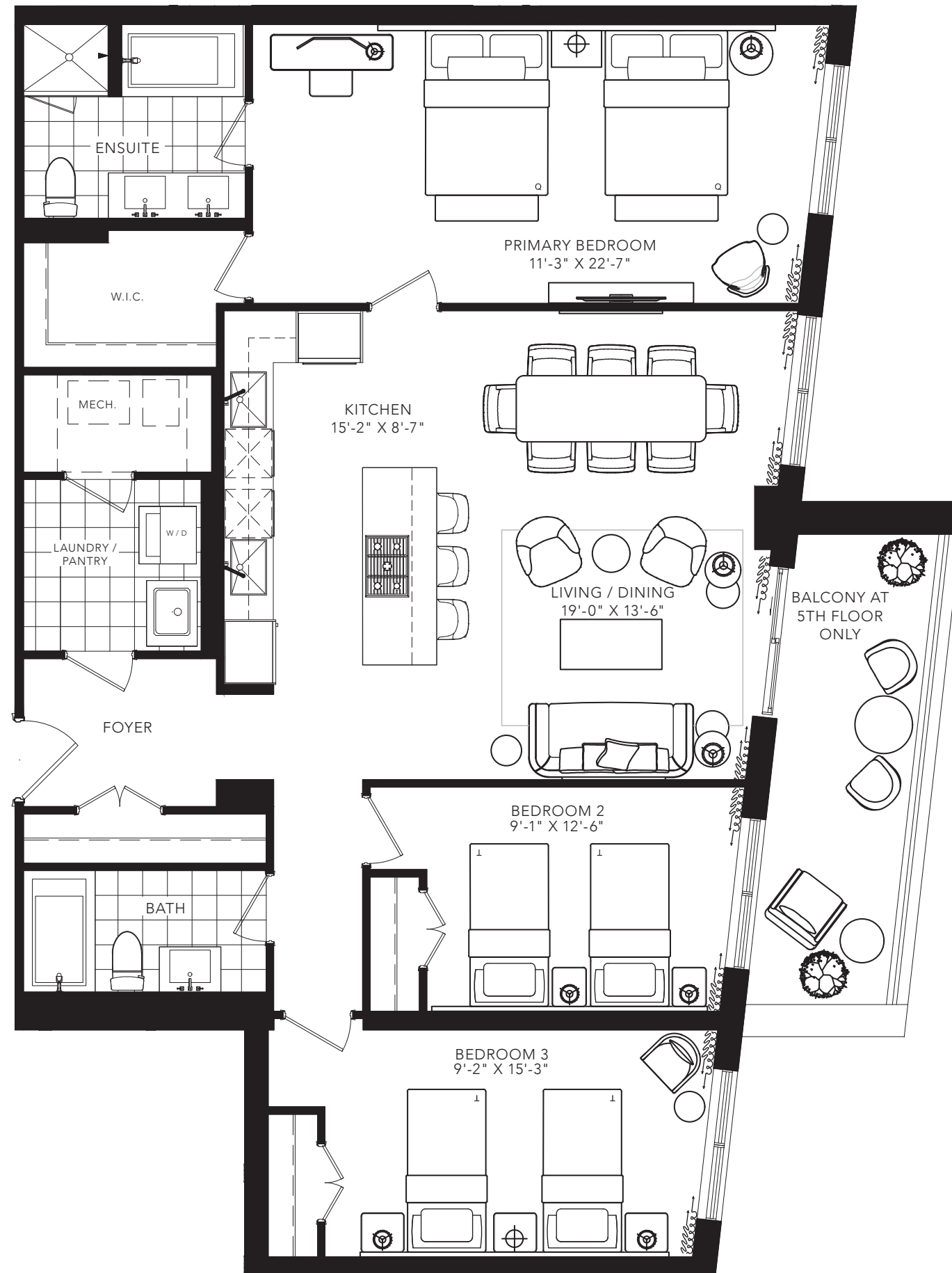

All areas and stated room dimensions are approximate. Floor area measured in accordance with Tarion requirements. Actual living area will vary from floor area stated. Furniture not included. Plan may be reversed. All illustrations are artist's concept. E. & O.E. March 2022.

LATIMER 2

2 BEDROOM + DEN
1629 SQ. FT.

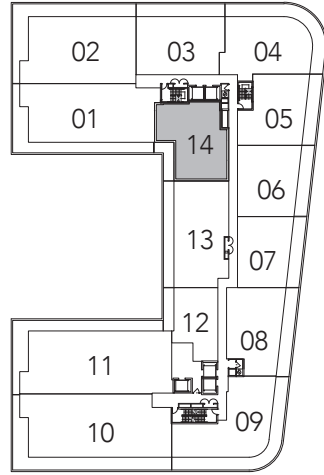

FLOOR 4

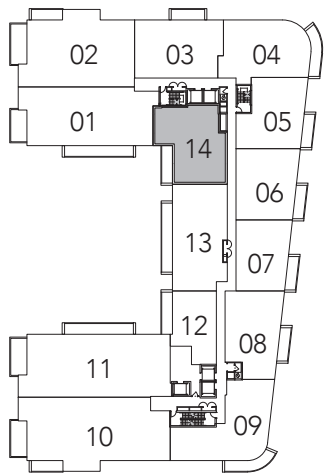

FLOOR 5

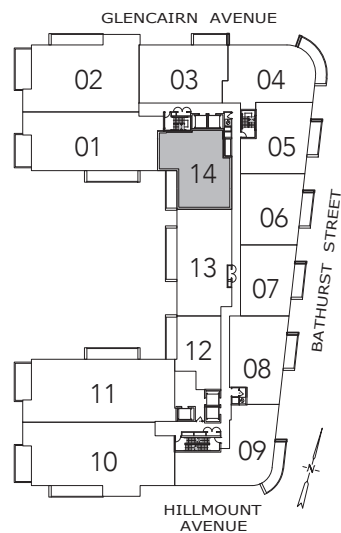

FLOOR 6

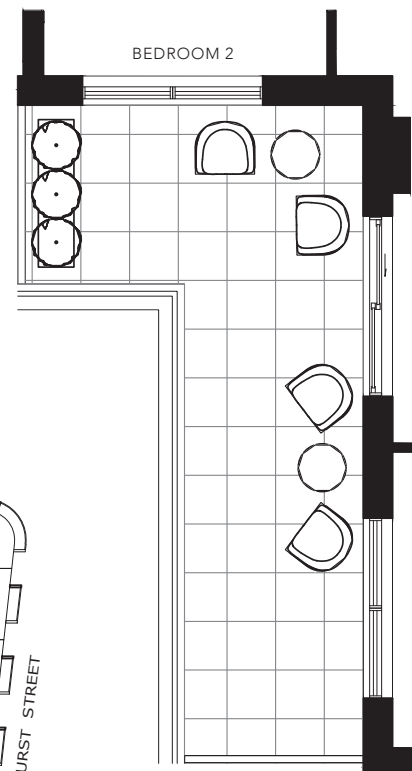

4TH FLOOR TERRACE

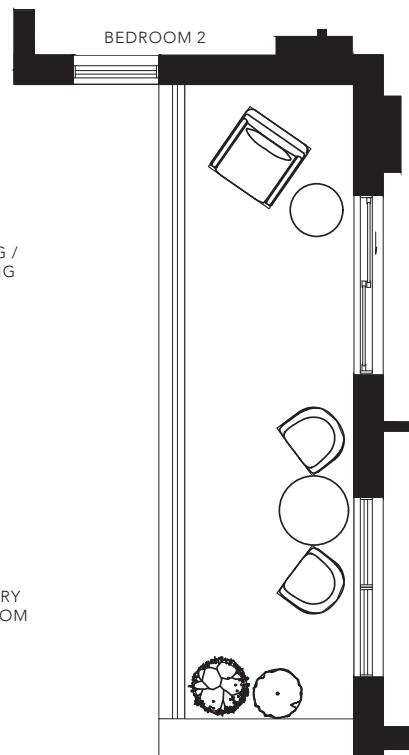

6TH FLOOR BALCONY

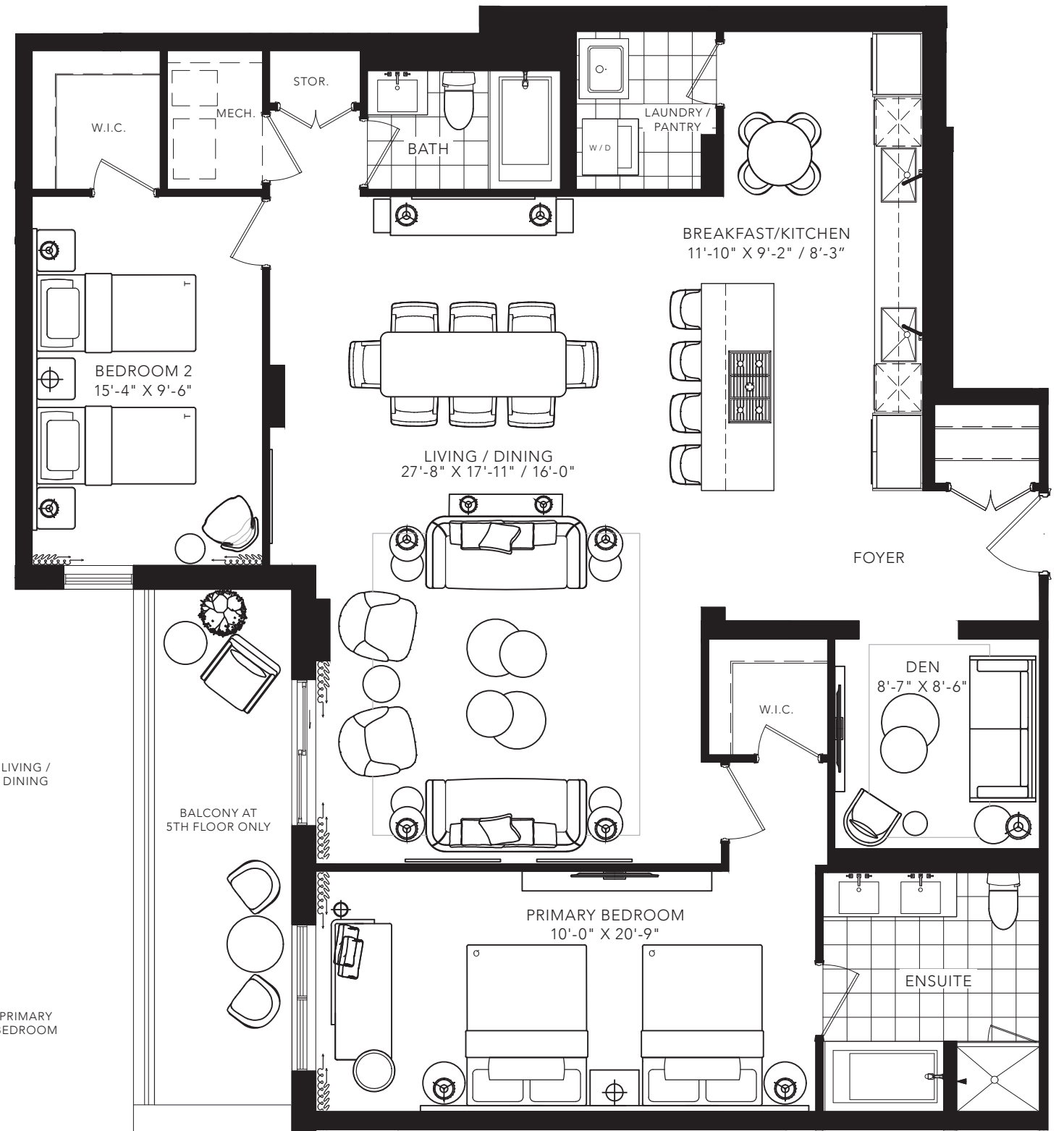

All areas and stated room dimensions are approximate. Floor area measured in accordance with Tarion requirements. Actual living area will vary from floor area stated. Furniture not included. Plan may be reversed. All illustrations are artist's concept. E. & O.E. March 2022.

MONTRESSOR

3 BEDROOM

1646 SQ. FT.

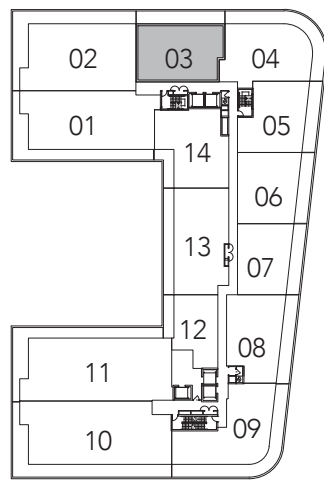

FLOOR 4

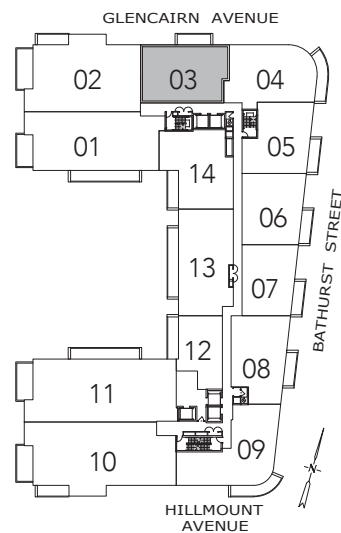

FLOOR 5

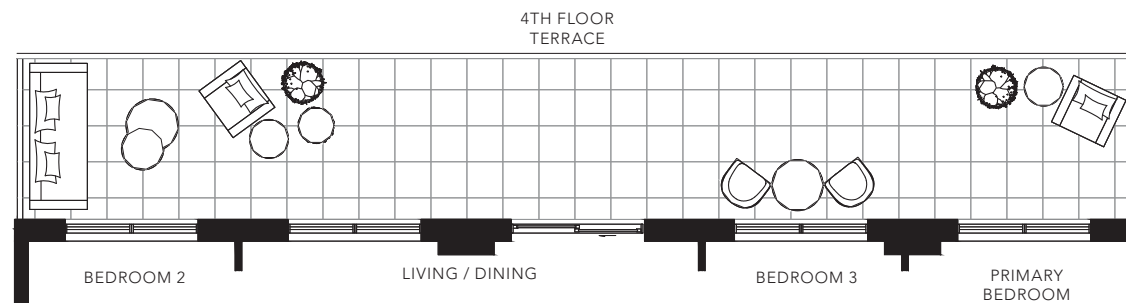

All areas and stated room dimensions are approximate. Floor area measured in accordance with Tarion requirements. Actual living area will vary from floor area stated. Furniture not included. Plan may be reversed. All illustrations are artist's concept. E. & O.E. May 2021.

ALNESS

3 BEDROOM
 1646 SQ. FT.

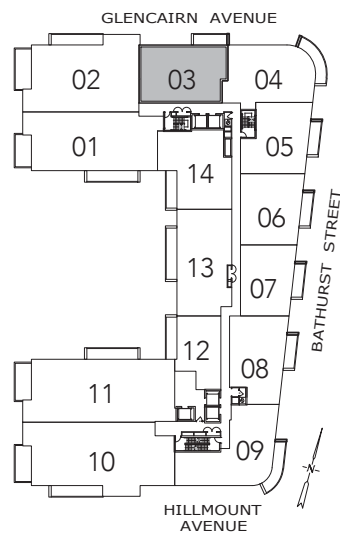
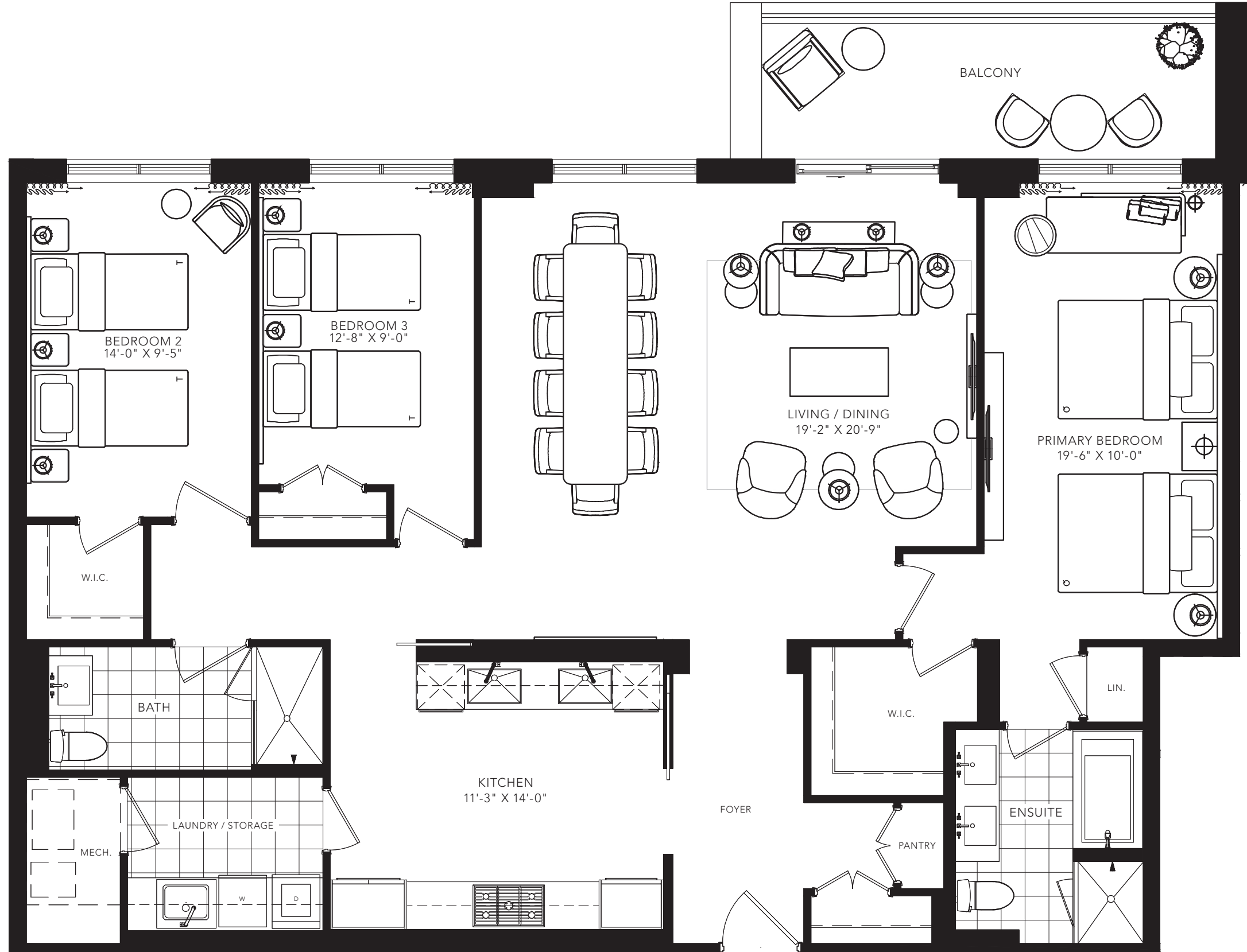

FLOOR 6

All areas and stated room dimensions are approximate. Floor area measured in accordance with Tarion requirements. Actual living area will vary from floor area stated. Furniture not included. Plan may be reversed. All illustrations are artist's concept. E. & O.E. May 2021.

GREY 2

2 BEDROOM + DEN
1662 SQ. FT.

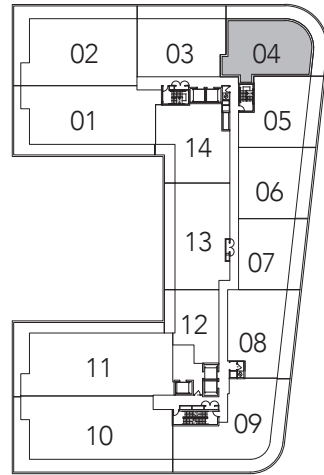

FLOOR 4

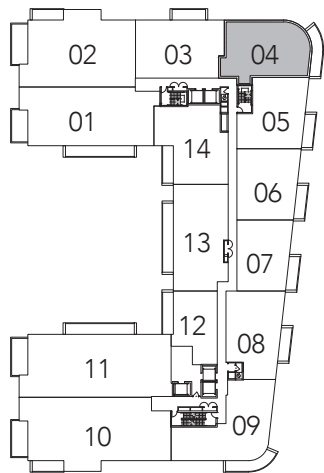

FLOOR 5

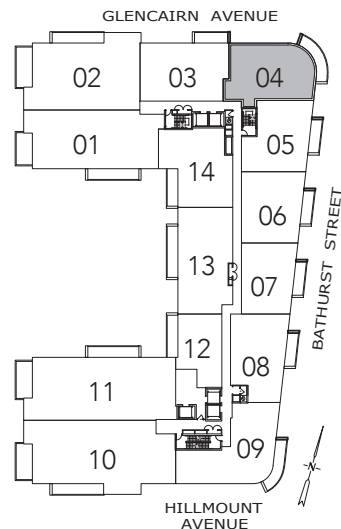

FLOOR 6

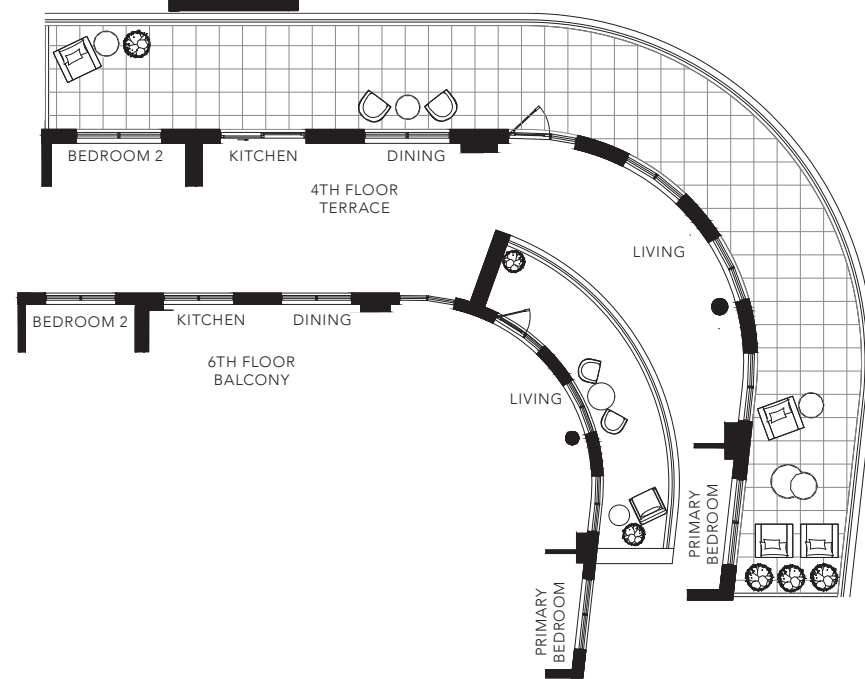
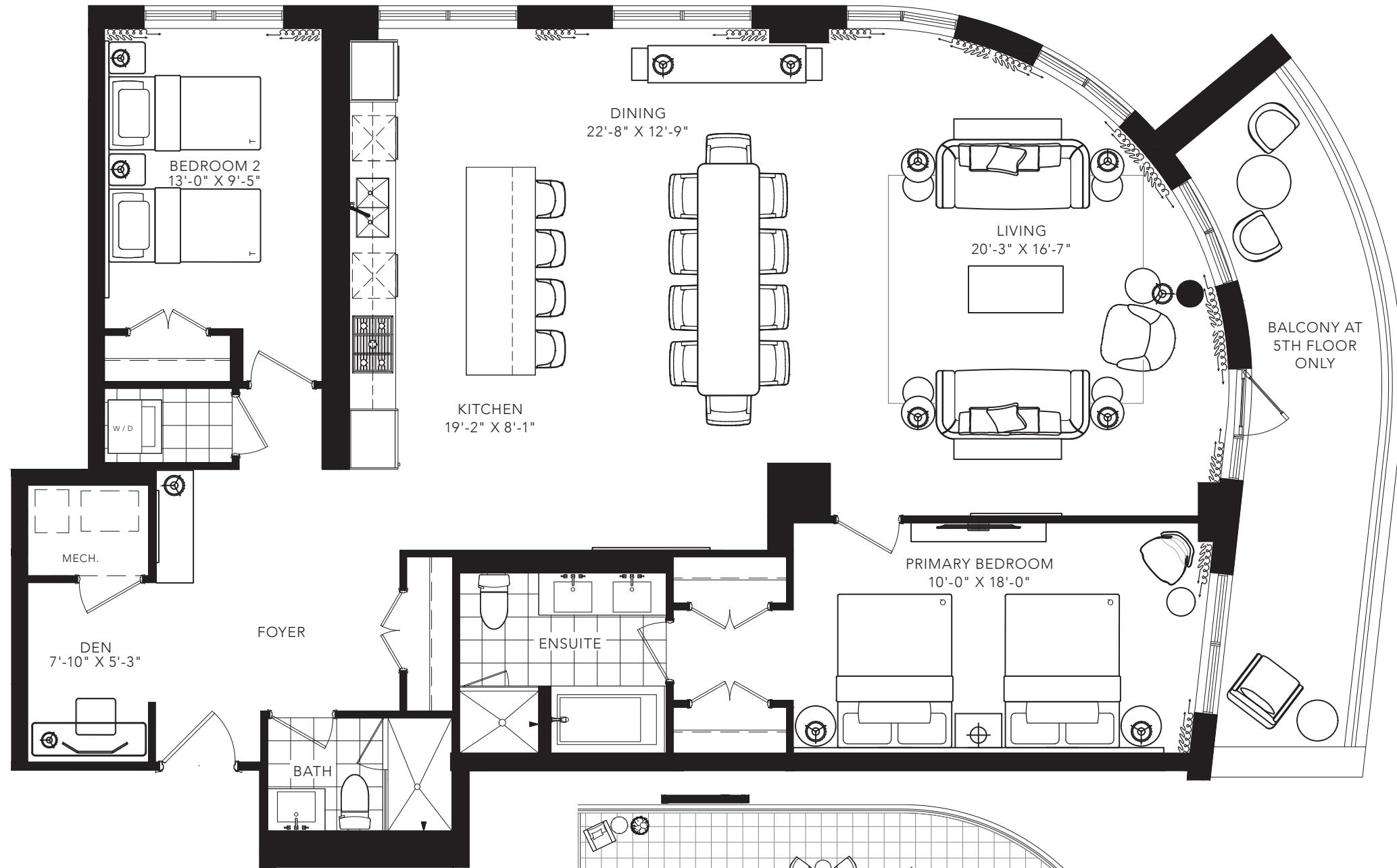

All areas and stated room dimensions are approximate. Floor area measured in accordance with Tarion requirements. Actual living area will vary from floor area stated. Furniture not included. Plan may be reversed. All illustrations are artist's concept. E. & O.E. March 2022.

FRONTENAC

2 BEDROOM + DEN
2493 SQ. FT.

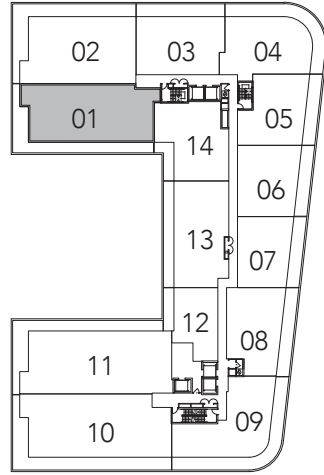

FLOOR 4

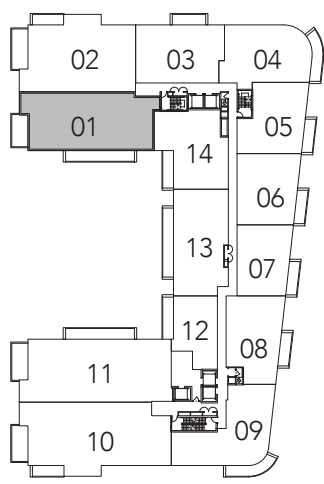

FLOOR 5

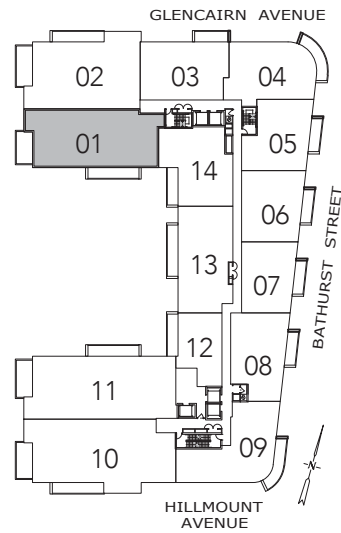

FLOOR 6



All areas and stated room dimensions are approximate. Floor area measured in accordance with Tarion requirements. Actual living area will vary from floor area stated. Furniture not included. Plan may be reversed. All illustrations are artist's concept. E. & O.E. May 2021.

KENWOOD

2 BEDROOM + DEN
2940 SQ. FT.

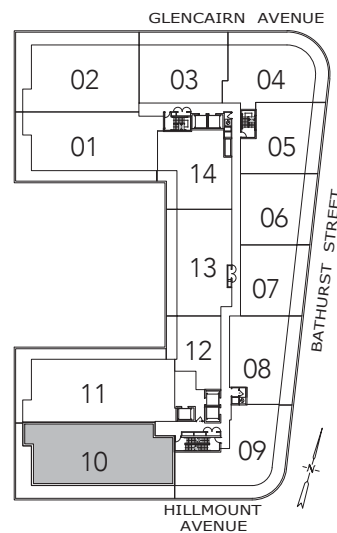
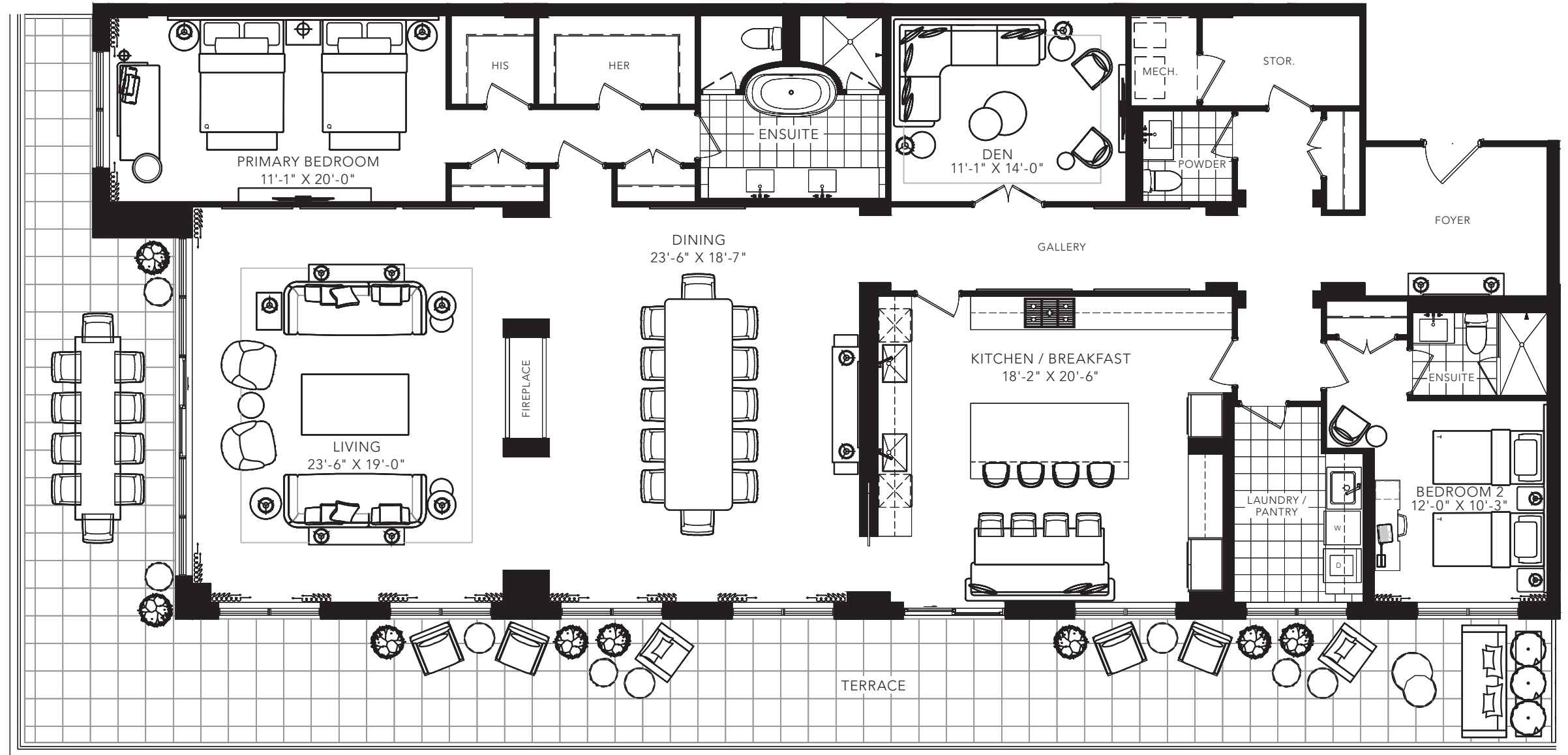

FLOOR 4

All areas and stated room dimensions are approximate. Floor area measured in accordance with Tarion requirements. Actual living area will vary from floor area stated. Furniture not included. Plan may be reversed. All illustrations are artist's concept. E. & O.E. May 2021.

MAYFAIR

3 BEDROOM + DEN
3026 SQ. FT.

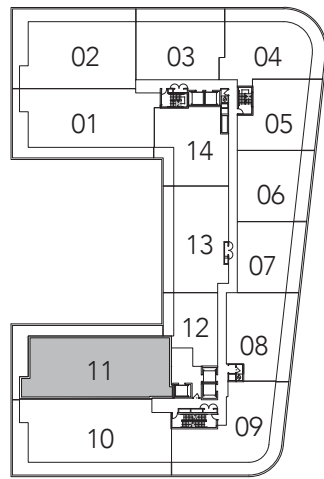
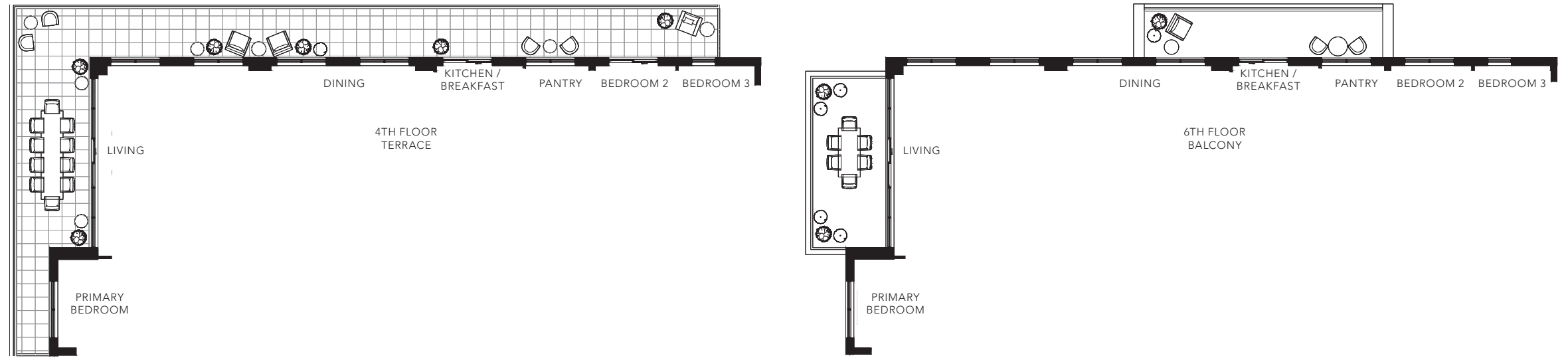

FLOOR 4

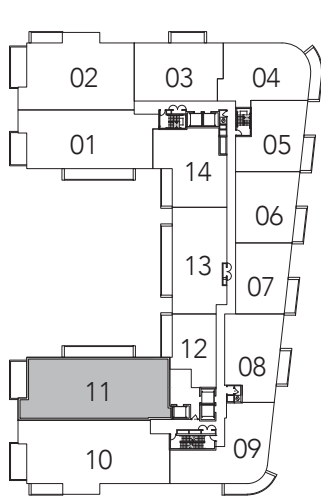

FLOOR 5

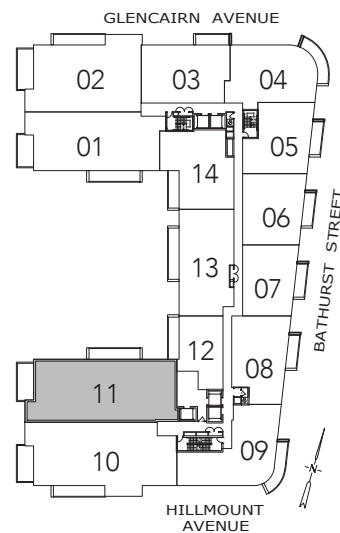

FLOOR 6

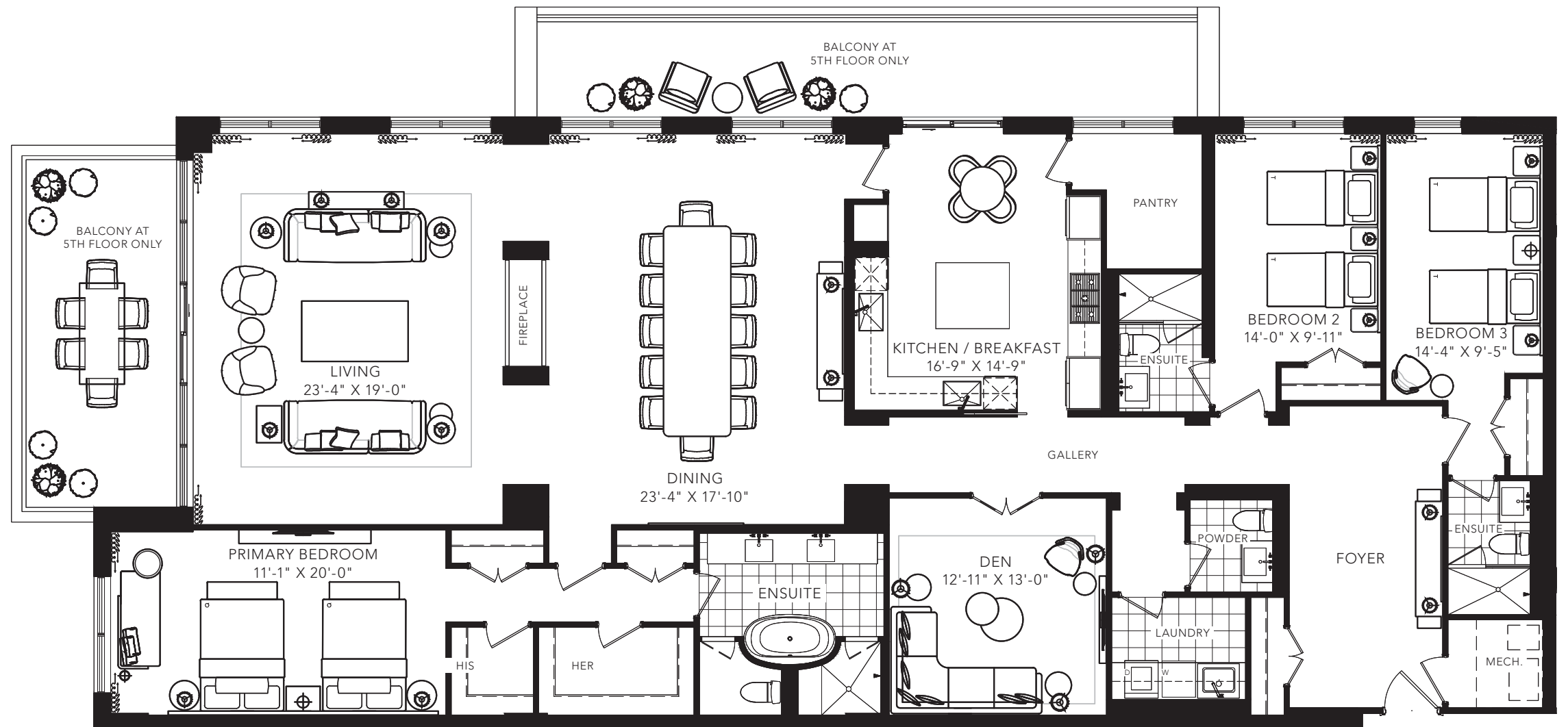

All areas and stated room dimensions are approximate. Floor area measured in accordance with Tarion requirements. Actual living area will vary from floor area stated. Furniture not included. Plan may be reversed. All illustrations are artist's concept. E. & O.E. May 2021.

MANNING

2 BEDROOM + DEN
 3070 SQ. FT.

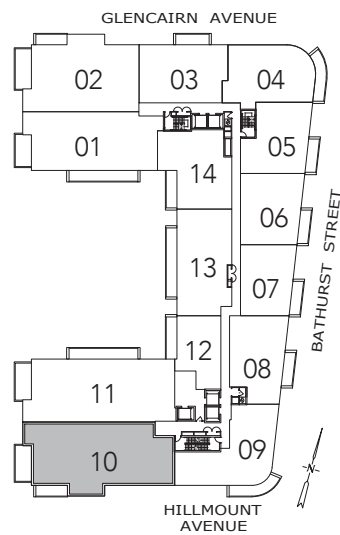
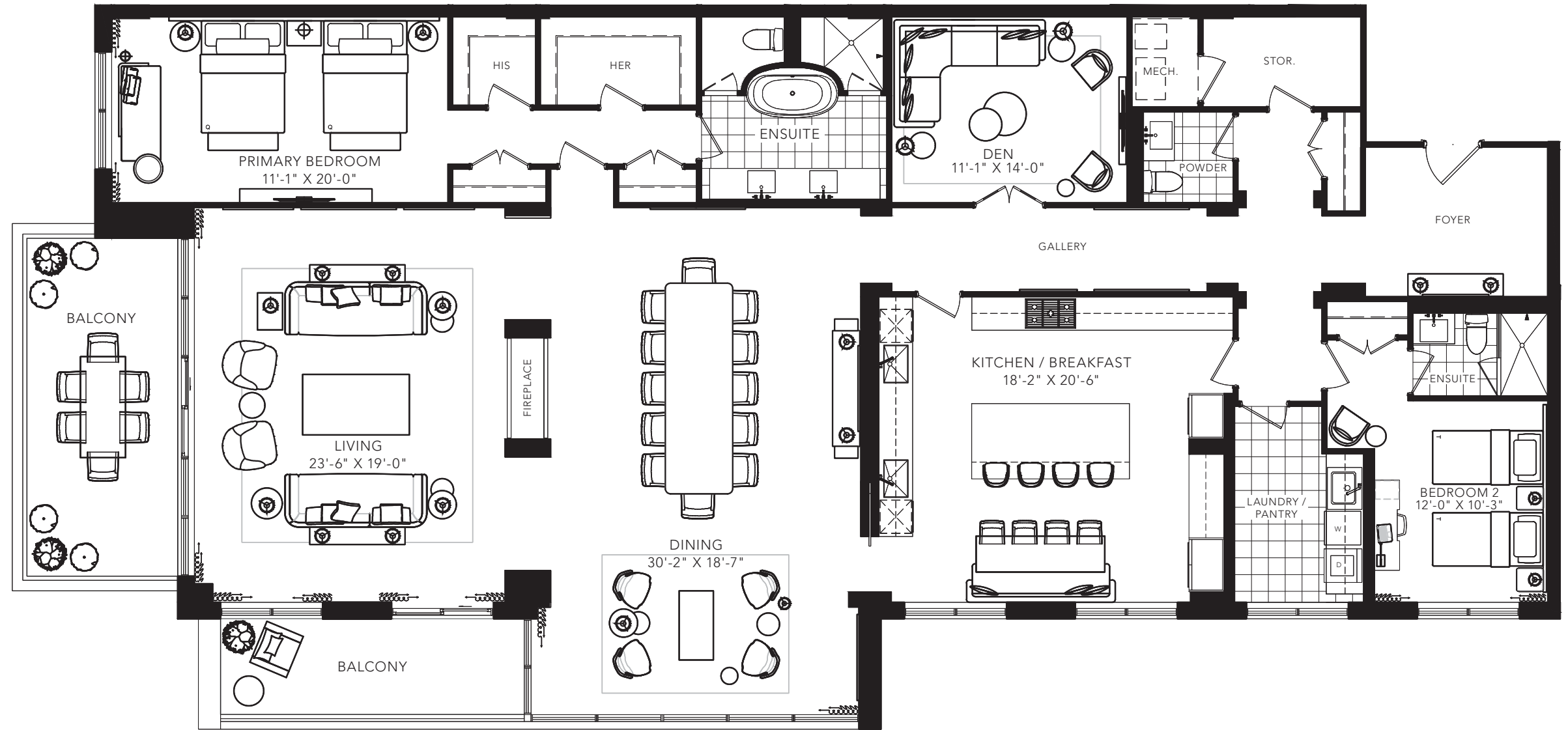

FLOOR 5

All areas and stated room dimensions are approximate. Floor area measured in accordance with Tarion requirements. Actual living area will vary from floor area stated. Furniture not included. Plan may be reversed. All illustrations are artist's concept. E. & O.E. May 2021.